

GLOBAL STANDARDS LOCAL EXCELLENCE

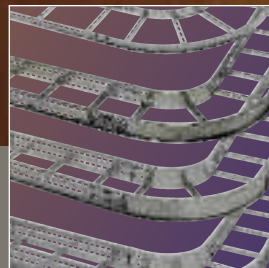

INDUSTRIAL CABLE LADDER
CATALOGUE

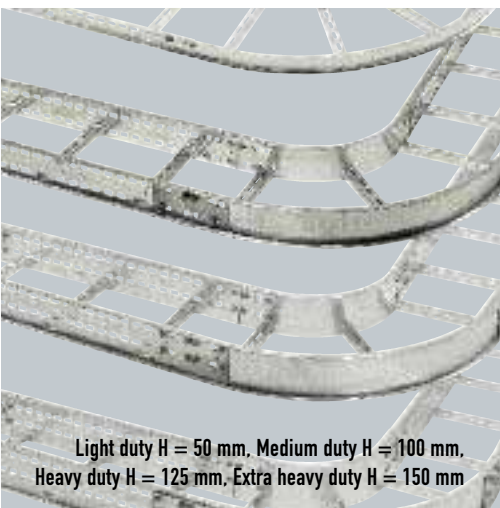

Light duty H = 50 mm, Medium duty H = 100 mm,
Heavy duty H = 125 mm, Extra heavy duty H = 150 mm

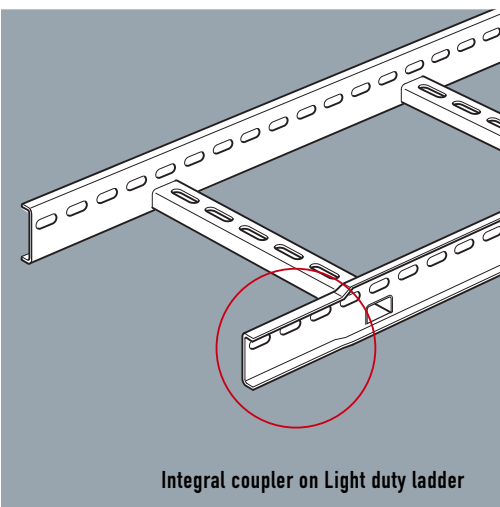

Integral coupler on Light duty ladder

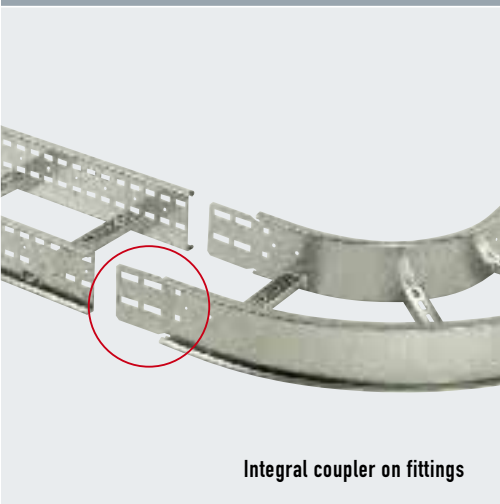

Integral coupler on fittings

INDUSTRIAL CABLE LADDER CATALOGUE

Introduction	02
Reference list	09
<hr/>	
INDUSTRIAL CABLE LADDER	12 - 57
Introduction	12
Loading graphs	14
HOT DIP GALVANISED	18-39
Light duty H= 50 mm	18
Medium duty H = 100 mm	22
Heavy duty H = 125 mm	28
Extra heavy duty H = 150 mm	34
STAINLESS STEEL 316 L	40-51
Medium duty H = 100 mm	40
Heavy duty H = 125 mm	46
Technical information	52
<hr/>	
SUPPORTS & BRACKETS	58 - 73
Introduction	58
Loading graphs	60
HOT DIP GALVANISED	62
STAINLESS STEEL 316 L	68
Technical information	70
<hr/>	
SWIFTRACK CHANNEL	74 - 81
Introduction	74
Loading graph	76
Pregalvanised/electro-galvanised	76
HOT DIP GALVANISED	77
STAINLESS STEEL 316 L	78
Technical information	79

Cable ladder program

Heavy industry

Dedicated to the heavy industry Legrand offers ONE universal cable ladder programme with worldwide availability. ONE programme specially designed for heavy duty circumstances and very wide spans. This world standard offers the optimal choice and flexibility due to the total offer from Light, Medium, Heavy to Extra heavy duty solutions. ONE world standard for cable ladders from Legrand offers maximum safety, durability and reliability at extreme circumstances.



**GLOBAL
STANDARDS
LOCAL
EXCELLENCE**

GLOBAL STANDARDS, LOCAL EXCELLENCE

From now on for each project it is possible to work with the same reliable system. This worldwide availability offers optimal choice, efficiency, constant quality, global know-how, product optimisation but above all: ease of installation and timesaving. The new global standard from Legrand offers you the best opportunity to exceed your competition.

ADVANTAGE BY STANDARDISATION

Worldwide standardisation offers clear timesaving and cost reduction. This in relation to engineering, purchasing, maintenance, logistics, administration, test and inspection, documentation, training and mounting.

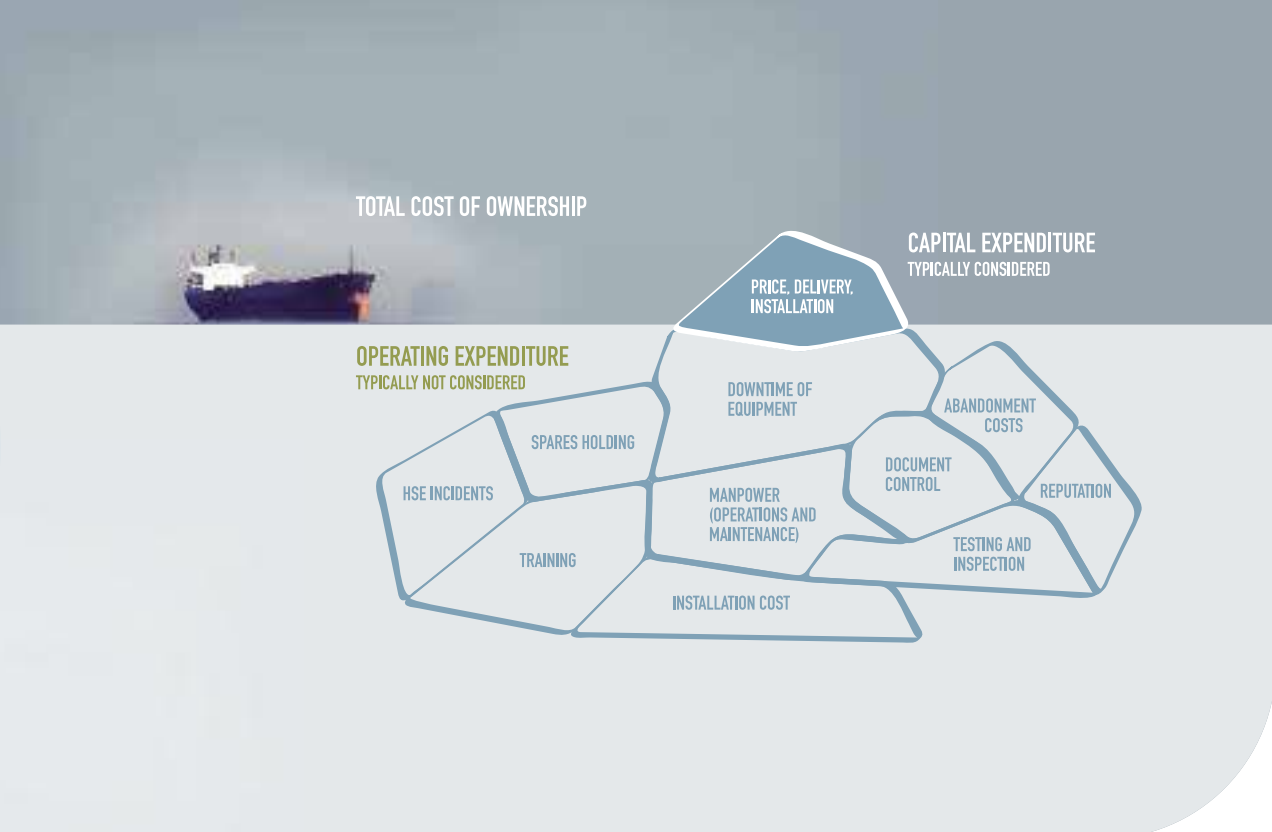



4



Dedicated to the heavy industry

Large spans
Maximum safety
Heavy loads

PERFORMANCE IN EXTREME CIRCUMSTANCES

Legrand knows the extreme circumstances in the heavy industry. Day-to-day you have to meet the toughest demands like maximum safety, durability and reliability without compromise.

ALL IN ONE COMPREHENSIVE SYSTEM

The Cable management range includes all components and systems that the heavy industry needs. A total solution for every environment and every application, allowing the best choices to be made.

Legrand cable ladders

- This systems has many variations in loading capacity and dimensions, combined with a large range of fittings and accessories, this systems offers flexibility and ease of installation.
- Four heights: Light duty (H50), Medium duty (H100), Heavy duty (H125) and Extra heavy duty (H150)
- A suitable finish for every environment: Hot dip galvanised and Stainless steel 316L (pickled and passivated) as standard.
- Standard radius of fittings is 300 mm, other radii available on request.
- Flat bends in 45 and 90 degree angles as standard.
- Complete range of fittings, accessories and support systems.
- Available in 3 and 6 m lengths.

World standard in steel wire tray

Cablofil is the most tested and certified steel wire cable tray system.

Cablofil meets the highest demands and offers the best mechanical characteristics and fastest installation.

The patented safe-T-Edge™ technology protects both cable and installer.



Light duty H = 50 mm

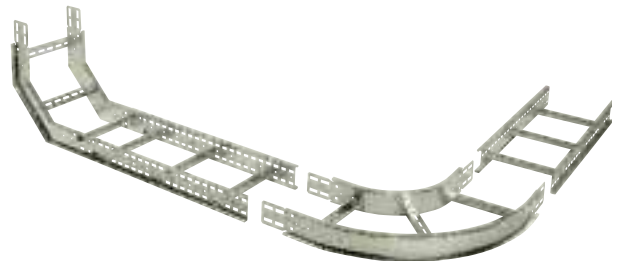

Medium duty H = 100 mm

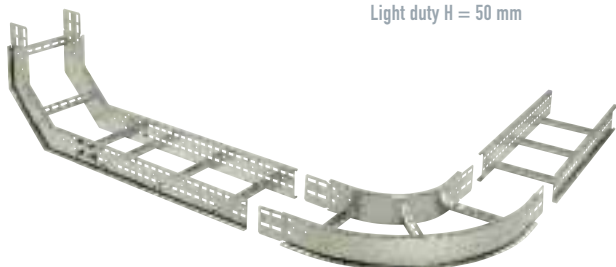

Heavy duty H = 125 mm

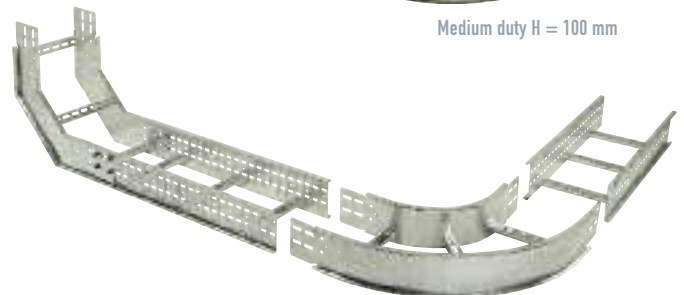

Extra heavy duty H = 150 mm



6



More than just products

GLOBAL SERVICE AND SUPPORT

Choice of material, product design and compatibility. The new standard in cable management systems has been developed specifically for the heavy industry. As a standard, Legrand clients can also rely on the extensive service and support.

Engineering support

- Every project is different. Legrand offers its experience and support in finding the best solution for every specific need.

Installation service

- Although Legrand products have been developed for optimal ease of installation, additional service and information is available.

Global presence

- For technical information and customer support.

TIME IS MONEY

In the development of new systems, ease of installation is the main criterion. The installation should be realised quickly and easily, but above all safety and durability must be guaranteed. The new cable ladder range for the heavy industry complies with all these demands.

- Integral coupler on fittings.
- Continuous perforation pattern for sidewalls, perfect fit for couplers without need for drilling even on cut lengths.
- Available in 3 and 6m lengths.
- Integral coupler on Light duty ladder H50.



ENGINEERING SUPPORT

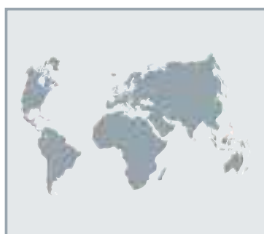

GLOBAL PRESENCE



INSTALLATION SUPPORT

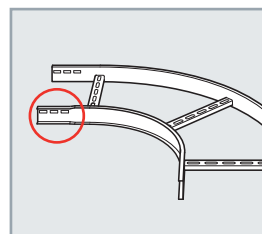

INTEGRATED COUPLER FOR FITTINGS

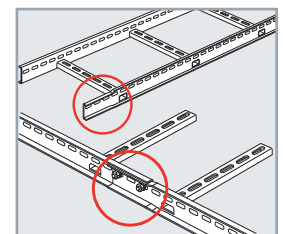

INTEGRATED COUPLER ON LIGHT DUTY LADDER

SAFETY FIRST

Designed for maximum safety

The new world standard for cable management integrates all of Legrand's knowledge and quality. All components have been designed for maximum safety, during installation as well as during its long life span. Safety features are often invisible, but it's those details that offer reliability and durability, even under extreme circumstances.

Tests

- All Legrand products are tested to the highest standards.
The Cable management systems comply with European Standard IEC 61537.
The loading tests have been done according to the most demanding test type 1 of this standard.

Welded profiles

- For optimal rigidity and stability

Return flanges

- Ladder lengths and fittings have a return flange sidewall, offering extra strength and avoiding sharp edges.



LOAD TEST



WELDING INSTALLATION



RETURN FLANGE ON FITTINGS

Reference list

Ref.no.	Page	Pack.	Ref.no.	Page	Pack.	Ref.no.	Page	Pack.	Ref.no.	Page	Pack.	Ref.no.	Page	Pack.
4185-0101	68	1	80607 45	65	1	87665 13	63	1	AMB 600 GZ	24	1	EAR 900 GZ	38	1
4192-0100	68	25	80607 50	65	1	87665 14	63	1	AMB 750 GZ	32	1	EB 200 300R G	37	1
5572 03	65	1	80607 55	65	1	87665 15	63	1	AMB 900 GZ	32	1	EB 300 300R G	37	1
5572 33	62	1	80607 60	65	1	87665 16	63	1	BCV 200 300R GX	23	1	EB 450 300R G	37	1
5572 43	62	1	80607 65	65	1	87665 18	63	1	BCV 200 300R SX	43	1	EB 600 300R G	37	1
5572 53	62	1	80607 70	65	1	87665 20	63	1	BCV 300 300R GX	23	1	EB 750 300R G	37	1
5572 63	62	1	80607 75	65	1	87665 30	63	1	BCV 300 300R SX	43	1	EB 900 300R G	37	1
5572 73	62	1	80607 85	65	1	87665 45	63	1	BCV 450 300R GX	23	1	EB GZ	67	1
5573 83	62	1	80607 90	65	1	87665 50	63	10	BCV 450 300R SX	43	1	EC GZ	38	1
80400 35	69	1	80607 91	65	1	87665 60	63	10	BCV 600 300R GX	23	1	EDV GX	38	1
80406 25	69	1	80607 96	65	1	87665 70	63	10	BCV 600 300R SX	43	1	EE GZ	38	1
80406 30	69	1	80699 06	63	100	87667 02	64	1	BCV 750 300R GX	31	1	EEC	38	10
80406 35	69	1	80699 07	62	100	87667 03	64	1	BCV 750 300R SX	49	1	EF G	67	10
80406 40	69	1	80699 09	63	100	87667 04	64	1	BCV 900 300R GX	31	1	EFB 200 45 300 G	36	1
80406 45	69	1	80699 35	63	100	87667 05	64	1	BCV 900 300R SX	49	1	EFB 200 90 300 G	36	1
80406 50	69	1	80699 40	62	100	87667 06	64	1	CV 200 GX	22	1	EFB 300 45 300 G	36	1
80406 55	69	1	80699 43	62	100	87667 07	64	1	CV 200 SX	42	1	EFB 300 90 300 G	36	1
80406 60	69	1	82621 00	66	1	87667 08	64	1	CV 300 GX	22	1	EFB 450 45 300 G	36	1
80406 65	69	1	82621 00	66	1	87667 09	64	1	CV 300 SX	42	1	EFB 450 90 300 G	36	1
80406 70	69	1	82640 00	66	25	87667 10	64	1	CV 450 GX	22	1	EFB 600 45 300 G	36	1
80406 75	69	1	82640 00	66	25	87667 30	64	1	CV 450 SX	42	1	EFB 600 90 300 G	36	1
80406 85	69	1	87064 01	62	1	87667 60	64	1	CV 600 GX	22	1	EFB 750 45 300 G	36	1
80406 90	69	1	87064 02	63	1	87668 02	64	1	CV 600 SX	42	1	EFB 750 90 300 G	36	1
80406 91	69	1	87068 00	64	25	87668 03	64	1	CV 750 GX	30	1	EFB 900 45 300 G	36	1
80406 96	69	1	87634 70	64	1	87668 04	64	1	CV 750 SX	48	1	EFB 900 90 300 G	36	1
80499 06	68	100	87664 02	62	1	87668 05	64	1	CV 900 GX	30	1	EFC GZ	38	1
80499 09	68	100	87664 03	62	1	87668 06	64	1	CV 900 SX	48	1	EH GZ	38	1
80600 32	65	1	87664 04	62	1	87668 07	64	1	CVSTIFF 750 G	33	1	EIR 200 90 300 G	37	1
80600 35	67	1	87664 05	62	1	87668 08	64	1	CVSTIFF 750 S	51	1	EIR 300 90 300 G	37	1
80606 25	63	1	87664 06	62	1	87668 09	64	1	CVSTIFF 900 G	33	1	EIR 450 90 300 G	37	1
80606 30	63	1	87664 07	62	1	87668 10	64	1	CVSTIFF 900 S	51	1	EIR 600 90 300 G	37	1
80606 35	63	1	87664 08	62	1	87668 12	64	1	DO 200 GZ	24	1	EIR 750 90 300 G	37	1
80606 40	63	1	87664 09	62	1	87668 14	64	1	DO 200 SZ	44	1	EIR 900 90 300 G	37	1
80606 45	63	1	87664 10	62	1	87668 16	64	1	DO 300 GZ	24	1	EIRC 200 90 300 GX	37	1
80606 50	63	1	87664 11	62	1	87668 18	64	1	DO 300 SZ	44	1	EIRC 300 90 300 GX	37	1
80606 55	63	1	87664 12	62	1	87668 20	64	1	DO 450 GZ	24	1	EIRC 450 90 300 GX	37	1
80606 60	63	1	87664 45	62	4	87668 81	64	10	DO 450 SZ	44	1	EIRC 600 90 300 GX	37	1
80606 65	63	1	87665 02	63	6	87668 82	64	5	DO 600 GZ	24	1	EIRC 750 90 300 GX	37	1
80606 70	63	1	87665 03	63	10	87668 83	64	1	DO 600 SZ	44	1	EIRC 900 90 300 GX	37	1
80606 75	63	1	87665 04	63	1	87668 84	64	20	DO 750 GZ	32	1	EJ G	67	10
80606 85	63	1	87665 05	63	1	87668 85	64	20	DO 750 SZ	50	1	EL 200 G 6M	36	1
80606 90	63	1	87665 06	63	1	87668 86	64	10	DO 900 GZ	32	1	EL 300 G 6M	36	1
80606 91	63	1	87665 07	63	1	87668 87	64	5	DO 900 SZ	50	1	EL 450 G 6M	36	1
80606 96	63	1	87665 08	63	1	87695 01	62	20	EAR 200 GZ	38	1	EL 600 G 6M	36	1
80607 25	65	1	87665 09	63	1	87695 02	62	10	EAR 300 GZ	38	1	EL 750 G 6M	36	1
80607 30	65	1	87665 10	63	1	AMB 200 GZ	24	1	EAR 450 GZ	38	1	EL 900 G 6M	36	1
80607 35	65	1	87665 11	63	1	AMB 300 GZ	24	1	EAR 600 GZ	38	1	EN GZ	67	1
80607 40	65	1	87665 12	63	1	AMB 450 GZ	24	1	EAR 750 GZ	38	1	EOR 200 90 300 G	37	1

Ref.no.	Page	Pack.
EOR 300 90 300 G	37	1
EOR 450 90 300 G	37	1
EOR 600 90 300 G	37	1
EOR 750 90 300 G	37	1
EOR 900 90 300 G	37	1
EORC 200 90 300 GX	37	1
EORC 300 90 300 GX	37	1
EORC 450 90 300 GX	37	1
EORC 600 90 300 GX	37	1
EORC 750 90 300 GX	37	1
EORC 900 90 300 GX	37	1
EP GZ	67	1
ER 100 GZ	38	1
ER 150 GZ	38	1
ER 50 GZ	38	1
ER 75 GZ	38	1
ET 200 300R G	37	1
ET 300 300R G	37	1
ET 450 300R G	37	1
ET 600 300R G	37	1
ET 750 300R G	37	1
ET 900 300R G	37	1
ETB GZ	38	1
EV GZ	38	1
EWSB GZ	67	1
FBCV 200 45 300 GX	22	1
FBCV 200 45 300 SX	42	1
FBCV 200 90 300 GX	22	1
FBCV 200 90 300 SX	42	1
FBCV 300 45 300 GX	22	1
FBCV 300 45 300 SX	42	1
FBCV 300 90 300 GX	22	1
FBCV 300 90 300 SX	42	1
FBCV 450 45 300 GX	22	1
FBCV 450 45 300 SX	42	1
FBCV 450 90 300 GX	22	1
FBCV 450 90 300 SX	42	1
FBCV 600 45 300 GX	22	1
FBCV 600 45 300 SX	42	1
FBCV 600 90 300 GX	22	1
FBCV 600 90 300 SX	42	1
FBCV 750 45 300 GX	30	1
FBCV 750 45 300 SX	48	1
FBCV 750 90 300 GX	30	1
FBCV 750 90 300 SX	48	1
FBCV 900 45 300 GX	30	1
FBCV 900 45 300 SX	48	1
FBCV 900 90 300 GX	30	1
FBCV 900 90 300 SX	48	1
FL2	66	1
HTH 200 G	66	1
HTH 200 S	68	1
HTH 300 G	66	1

Ref.no.	Page	Pack.
HTH 300 S	68	1
HTH 450 G	66	1
HTH 450 S	68	1
HTH 600 G	66	1
HTH 600 S	68	1
LF G M10	25	50
LF S M10	45	30
LFCC G M8	24	30
LFCC S M8	44	30
LFCCOV G M6	25	50
LFCCOV S M6	45	50
LFDV G M6	21	100
LFDV S M6	45	100
LTH 225 G	66	1
LTH 300 G	66	1
LTH 450 G	66	1
M GZ	25	1
M SZ	45	50
MP GZ	20	1
MP SZ	44	1
OAMB 200 GZ	20	1
OAMB 300 GZ	20	1
OAMB 450 GZ	20	1
OB GZ	67	1
OC GZ	20	1
ODV GX	20	1
OEC	21	10
OF G	67	10
OFAST G	21	1
OFB 200 90 300 G	20	1
OFB 300 90 300 G	20	1
OFB 450 90 300 G	20	1
OH GZ	20	1
OIR 200 90 300 G	20	1
OIR 300 90 300 G	20	1
OIR 450 90 300 G	20	1
OJ G	67	10
OL 200 G	20	1
OL 300 G	20	1
OL 450 G	20	1
OOR 200 90 300 G	20	1
OOR 300 90 300 G	20	1
OOR 450 90 300 G	20	1
ORB GZ	66	1
OT 200 300R G	20	1
OT 300 300R G	20	1
OT 450 300R G	20	1
OV GZ	21	1
OWSB GZ	67	1
PAR 200 GZ	32	1
PAR 200 SZ	50	1
PAR 300 GZ	32	1
PAR 300 SZ	50	1

Ref.no.	Page	Pack.
PAR 450 GZ	32	1
PAR 450 SZ	50	1
PAR 600 GZ	32	1
PAR 600 SZ	50	1
PAR 750 GZ	32	1
PAR 750 SZ	50	1
PAR 900 GZ	32	1
PAR 900 SZ	50	1
PB 200 300R G	31	1
PB 200 300R S	49	1
PB 300 300R G	31	1
PB 300 300R S	49	1
PB 450 300R G	31	1
PB 450 300R S	49	1
PB 600 300R G	31	1
PB 600 300R S	49	1
PB 750 300R G	31	1
PB 750 300R S	49	1
PB 900 300R G	31	1
PB 900 300R S	49	1
PB GZ	67	1
PB SZ	69	1
PC GZ	32	1
PC SZ	50	1
PDV GX	32	1
PDV SX	50	1
PE GZ	32	1
PE SZ	50	1
PEC	32	10
PF G	67	10
PF S	69	1
PFB 200 45 300 G	30	1
PFB 200 45 300 S	48	1
PFB 200 90 300 G	30	1
PFB 200 90 300 S	48	1
PFB 300 45 300 G	30	1
PFB 300 45 300 S	48	1
PFB 300 90 300 G	30	1
PFB 300 90 300 S	48	1
PFB 450 45 300 G	30	1
PFB 450 45 300 S	48	1
PFB 450 90 300 G	30	1
PFB 450 90 300 S	48	1
PFB 600 45 300 G	30	1
PFB 600 45 300 S	48	1
PFB 600 90 300 G	30	1
PFB 600 90 300 S	48	1
PFB 750 45 300 G	30	1
PFB 750 45 300 S	48	1
PFB 750 90 300 G	30	1
PFB 750 90 300 S	48	1
PFB 900 45 300 G	30	1
PFB 900 45 300 S	48	1

Ref.no.	Page	Pack.
PFB 900 90 300 G	30	1
PFB 900 90 300 S	48	1
PFC GZ	32	1
PFC SZ	50	1
PFIN SZ	69	1
PH GZ	32	1
PH SZ	50	1
PIR 200 90 300 G	31	1
PIR 200 90 300 S	49	1
PIR 300 90 300 G	31	1
PIR 300 90 300 S	49	1
PIR 450 90 300 G	31	1
PIR 450 90 300 S	49	1
PIR 600 90 300 G	31	1
PIR 600 90 300 S	49	1
PIR 750 90 300 G	31	1
PIR 750 90 300 S	49	1
PIR 900 90 300 G	31	1
PIR 900 90 300 S	49	1
PIRC 200 90 300 GX	31	1
PIRC 200 90 300 SX	49	1
PIRC 300 90 300 GX	31	1
PIRC 300 90 300 SX	49	1
PIRC 450 90 300 GX	31	1
PIRC 450 90 300 SX	49	1
PIRC 600 90 300 GX	31	1
PIRC 600 90 300 SX	49	1
PIRC 750 90 300 GX	31	1
PIRC 750 90 300 SX	49	1
PIRC 900 90 300 GX	31	1
PIRC 900 90 300 SX	49	1
PJ G	67	10
PJ S	69	1
PJIN SZ	69	1
PL 200 G	30	1
PL 200 G 6M	30	1
PL 200 S	48	1
PL 300 G	30	1
PL 300 G 6M	30	1
PL 300 S	48	1
PL 450 G	30	1
PL 450 G 6M	30	1
PL 450 S	48	1
PL 600 G	30	1
PL 600 G 6M	30	1
PL 600 S	48	1
PL 750 G	30	1
PL 750 G 6M	30	1
PL 750 S	48	1
PL 900 G	30	1
PL 900 G 6M	30	1
PL 900 S	48	1
PLFEB	25	10

Ref.no.	Page	Pack.
PN 060	76	100
PN 060 G	77	100
PN 060 S	78	100
PN 061	76	100
PN 061 G	77	100
PN 061 S	78	100
PN 062	76	100
PN 062 G	77	100
PN 062 S	78	100
PN 080	76	100
PN 080 G	77	100
PN 080 S	78	100
PN 081	76	100
PN 081 G	77	100
PN 081 S	78	100
PN 082	76	100
PN 082 G	77	100
PN 082 S	78	100
PN 100	76	100
PN 100 G	77	100
PN 100 S	78	100
PN 101	76	100
PN 101 G	77	100
PN 101 S	78	100
PN 102	76	100
PN 102 G	77	100
PN 102 S	78	100
PN 120	76	100
PN 120 G	77	100
PN 120 S	78	100
PN 121	76	100
PN 121 G	77	100
PN 121 S	78	100
PN 122	76	100
PN 122 G	77	100
PN 122 S	78	100
PN GZ	67	1
PN SZ	69	1
POR 200 90 300 G	31	1
POR 200 90 300 S	49	1
POR 300 90 300 G	31	1
POR 300 90 300 S	49	1
POR 450 90 300 G	31	1
POR 450 90 300 S	49	1
POR 600 90 300 G	31	1
POR 600 90 300 S	49	1
POR 750 90 300 G	31	1
POR 750 90 300 S	49	1
POR 900 90 300 G	31	1
POR 900 90 300 S	49	1
PORC 200 90 300 GX	31	1
PORC 200 90 300 SX	49	1
PORC 300 90 300 GX	31	1

Ref.no.	Page	Pack.
PORC 300 90 300 SX	49	1
PORC 450 90 300 GX	31	1
PORC 450 90 300 SX	49	1
PORC 600 90 300 SX	49	1
PORC 600 90 400 GX	31	1
PORC 750 90 300 GX	31	1
PORC 750 90 300 SX	49	1
PORC 900 90 300 GX	31	1
PORC 900 90 300 SX	49	1
PP GZ	67	1
PP SZ	69	1
PR 100 GZ	32	1
PR 100 SZ	50	1
PR 150 GZ	32	1
PR 150 SZ	50	1
PR 50 GZ	32	1
PR 50 SZ	50	1
PR 75 GZ	32	1
PR 75 SZ	50	1
PT 200 300R G	31	1
PT 200 300R S	49	1
PT 300 300R G	31	1
PT 300 300R S	49	1
PT 450 300R G	31	1
PT 450 300R S	49	1
PT 600 300R G	31	1
PT 600 300R S	49	1
PT 750 300R G	31	1
PT 750 300R S	49	1
PT 900 300R G	31	1
PT 900 300R S	49	1
PTB GZ	32	1
PTB SZ	50	1
PV GZ	32	1
PV SZ	50	1
PWSB GZ	67	1
PWSB SZ	69	1
SB 501	77	1
SB 501 S	78	1
SB 502	77	1
SB 502 S	78	1
SB 504	77	1
SB 504 S	78	1
SB 505	77	1
SB 505 S	78	1
SB 50612	77	1
SB 50612 S	78	1
SB 507	77	1
SB 507 S	78	1
SB 508	77	1
SB 508 S	78	1
SB 509	77	1
SB 509 S	78	1

Ref.no.	Page	Pack.
SB 511	77	1
SB 511 S	78	1
SB 512	77	1
SB 512 S	78	1
SB 513	77	1
SB 513 S	78	1
SB 514	77	1
SB 514 S	78	1
SB 515	77	1
SB 515 S	78	1
SB 516	77	1
SB 516 S	78	1
SB 517	77	1
SB 517 S	78	1
SB 524	77	1
SB 524 S	78	1
SB 600	77	1
SB 600 S	78	1
SB 603	77	1
SB 603 S	78	1
SB 650	77	1
SB 650 S	78	1
SB 651	77	1
SB 651 S	78	1
SB 700	77	1
SB 700 S	78	1
SB 703	77	1
SB 703 S	78	1
SB 704	77	1
SB 704 S	78	1
SB 705	77	1
SB 705 S	78	1
SC 200 3M	76	1
SC 200 3M G	77	1
SC 200 3M S	78	1
SC 203 3M	76	1
SC 203 3M G	77	1
SC 203 3M S	78	1
SC 400 3M	76	1
SC 400 3M G	77	1
SC 400 3M S	78	1
SC 401 3M G	77	1
SC 401 3M S	78	1
SC 403 3M	76	1
SC 403 3M G	77	1
SC 403 3M S	78	1
SC 850	77	1
SC 850 S	78	1
SC 851	77	1
SC 851 S	78	1
SC 85241	77	1
SC 85241 S	78	1
SC 853	77	1

Ref.no.	Page	Pack.
SC 853 S	78	1
SC 855	77	1
SC 855 S	78	1
SC 856	77	1
SC 856 S	78	1
SC 950 W	76	1
SC 951 W	76	1
SC 952	76	1
TCV 200 300R GX	23	1
TCV 200 300R SX	43	1
TCV 300 300R GX	23	1
TCV 300 300R SX	43	1
TCV 450 300R GX	23	1
TCV 450 300R SX	43	1
TCV 600 300R GX	23	1
TCV 600 300R SX	43	1
TCV 750 300R GX	31	1
TCV 750 300R SX	49	1
TCV 900 300R GX	31	1
TCV 900 300R SX	49	1
ZAR 200 GZ	24	1
ZAR 200 SZ	44	1
ZAR 300 GZ	24	1
ZAR 300 SZ	44	1
ZAR 450 GZ	24	1
ZAR 450 SZ	44	1
ZAR 600 GZ	24	1
ZAR 600 SZ	44	1
ZB 200 300R G	23	1
ZB 200 300R S	43	1
ZB 300 300R G	23	1
ZB 300 300R S	43	1
ZB 450 300R G	23	1
ZB 450 300R S	43	1
ZB 600 300R G	23	1
ZB 600 300R S	43	1
ZB GZ	67	1
ZB SZ	69	1
ZC GZ	24	1
ZC SZ	44	1
ZDV GX	24	1
ZDV SX	44	1
ZE GZ	24	1
ZE SZ	44	1
ZEC	24	10
ZF G	67	10
ZF S	69	1
ZFB 200 45 300 G	22	1
ZFB 200 45 300 S	42	1
ZFB 200 90 300 G	22	1
ZFB 200 90 300 S	42	1
ZFB 300 45 300 G	22	1
ZFB 300 45 300 S	42	1

Ref.no.	Page	Pack.
ZFB 300 90 300 G	22	1
ZFB 300 90 300 S	42	1
ZFB 450 45 300 G	22	1
ZFB 450 45 300 S	42	1
ZFB 450 90 300 G	22	1
ZFB 450 90 300 S	42	1
ZFB 600 45 300 G	22	1
ZFB 600 45 300 S	42	1
ZFB 600 90 300 G	22	1
ZFB 600 90 300 S	42	1
ZFC GZ	24	1
ZFC SZ	44	1
ZFIN SZ	69	1
ZH GZ	24	1
ZH SZ	44	1
ZIR 200 90 300 G	23	1
ZIR 200 90 300 S	43	1
ZIR 300 90 300 G	23	1
ZIR 300 90 300 S	43	1
ZIR 450 90 300 G	23	1
ZIR 450 90 300 S	43	1
ZIR 600 90 300 G	23	1
ZIR 600 90 300 S	43	1
ZIRC 200 90 300 GX	23	1
ZIRC 200 90 300 SX	43	1
ZIRC 300 90 300 GX	23	1
ZIRC 300 90 300 SX	43	1
ZIRC 450 90 300 GX	23	1
ZIRC 450 90 300 SX	43	1
ZIRC 600 90 300 GX	23	1
ZIRC 600 90 300 SX	43	1
ZJ G	67	10
ZJ S	69	1
ZJIN SZ	69	1
ZL 200 G	22	1
ZL 200 S	42	1
ZL 300 G	22	1
ZL 300 S	42	1
ZL 450 G	22	1
ZL 450 S	42	1
ZL 600 G	22	1
ZL 600 S	42	1
ZN GZ	67	1
ZN SZ	69	1
ZOR 200 90 300 G	23	1
ZOR 200 90 300 S	43	1
ZOR 300 90 300 G	23	1
ZOR 300 90 300 S	43	1
ZOR 450 90 300 G	23	1
ZOR 450 90 300 S	43	1
ZOR 600 90 300 G	23	1
ZOR 600 90 300 S	43	1
ZORC 200 90 300 GX	23	1

Ref.no.	Page	Pack.
ZORC 200 90 300 SX	43	1
ZORC 300 90 300 GX	23	1
ZORC 300 90 300 SX	43	1
ZORC 450 90 300 GX	23	1
ZORC 450 90 300 SX	43	1
ZORC 600 90 300 GX	23	1
ZORC 600 90 300 SX	43	1
ZP GZ	67	1
ZP SZ	69	1
ZR 100 GZ	24	1
ZR 100 SZ	44	1
ZR 150 GZ	24	1
ZR 150 SZ	44	1
ZR 50 GZ	24	1
ZR 50 SZ	44	1
ZR 75 GZ	24	1
ZR 75 SZ	44	1
ZRB GZ	66	1
ZRB SZ	68	1
ZT 200 300R G	23	1
ZT 200 300R S	43	1
ZT 300 300R G	23	1
ZT 300 300R S	43	1
ZT 450 300R G	23	1
ZT 450 300R S	43	1
ZT 600 300R G	23	1
ZT 600 300R S	43	1
ZTB GZ	24	1
ZTB SZ	44	1
ZV GZ	24	1
ZV SZ	44	1
ZWSB GZ	67	1
ZWSB SZ	69	1

Comprehensive system for heavy and extra heavy industrial applications

The industrial cable ladder is specifically designed for the stringent requirements within the industry and offshore. Even the most extreme loading and longest supporting distances, up to 8 meters can be accomplished. This meets the tendency of saving material and mounting time. The system is available in 4 types, Light, Medium, Heavy and Extra heavy duty.

■ Programme

	Maximum span	Heights	Widths	Lengths	Material/finishing
Cable ladder Light duty	2,5 m	50 mm	200, 300, 450 mm	3000 mm	Hot dip galvanised
Cable ladder Medium duty	4,5 m	100 mm	200, 300, 450, 600 mm	3000 mm	Hot dip galvanised Stainless Steel 316 L
Cable ladder Heavy duty	6 m	125 mm	200, 300, 450, 600, 750, 900 mm	3000 mm 6000 mm	Hot dip galvanised Stainless Steel 316 L
Cable ladder Extra heavy duty	8 m	150 mm	200, 300, 450, 600, 750, 900 mm	6000 mm	Hot dip galvanised

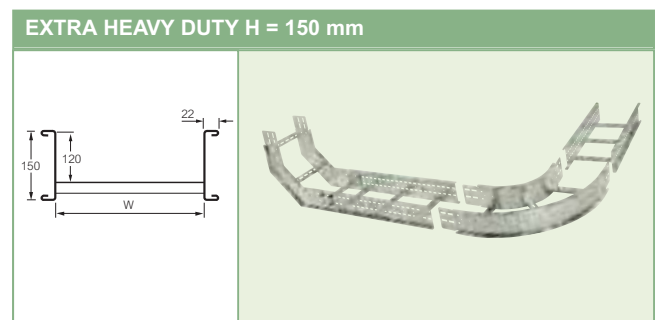
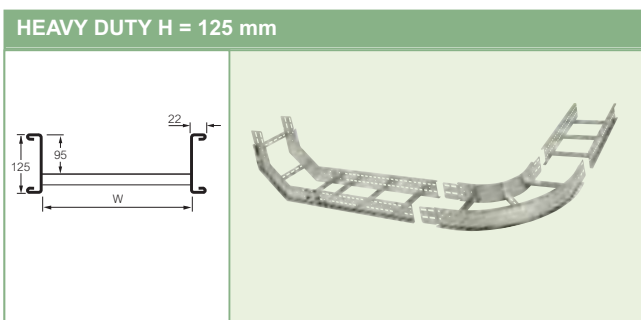
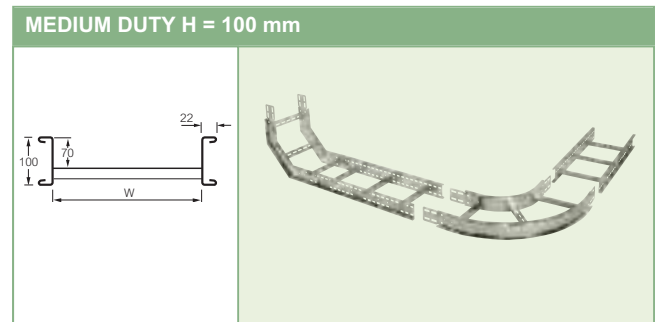
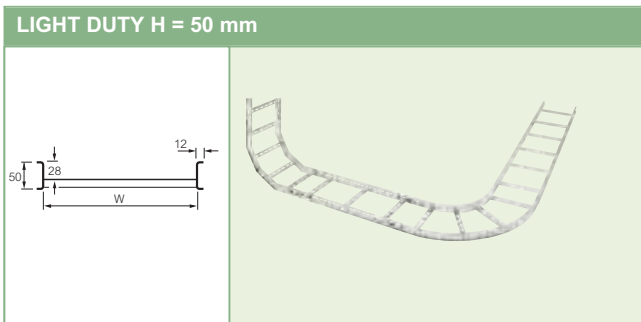

■ Characteristics

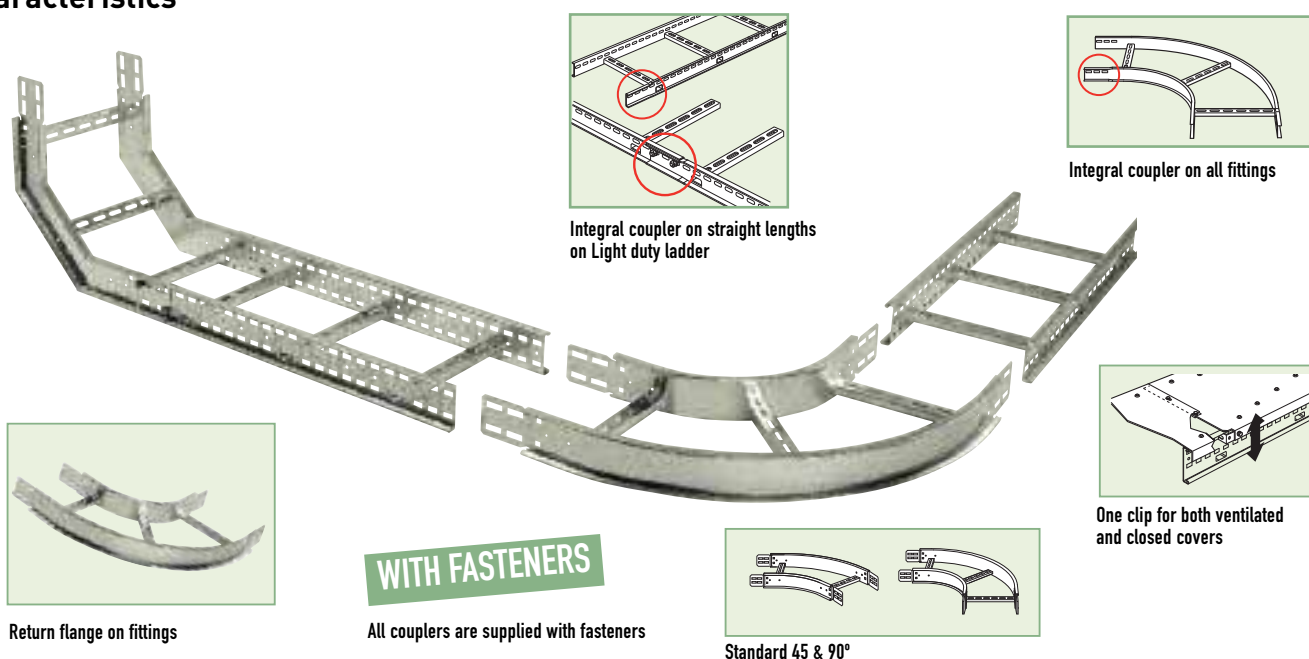

Return flange on fittings

WITH FASTENERS

All couplers are supplied with fasteners

Standard 45 & 90°

- One coherent system, 4 applications: Light duty, Medium duty, Heavy duty and Extra heavy duty.
- Complete range of fittings, accessories and support systems.
- Return flange on lengths and fittings provides extra strength and avoids sharp edges.
- For all environments there is a solution: hot dip galvanised and Stainless Steel 316L.
- Stainless Steel 316 L: all components are pickled and passivated as a standard, offering the best possible corrosion resistance and perfect optical quality.
- Available in 3 and 6 meter lengths.

- Multiple radii: 300 mm as standard, bigger radii on request.
- Multiple angles: 45 and 90 degree bends.
- Time saving integral couplers on the fittings.
- Integral coupler on the Light Duty Ladder.
- Continuous perforation pattern, possible to cut on every part of the ladder and no need for drilling.

■ Standards

- Loading graphs are in compliance with standard IEC 61537 (type 1)
- Hot dip galvanised in accordance with NEN EN 1461, minimum average zinc thickness is 55 µm.

Loading graphs

Loading graphs industrial ladders

■ Type of ladder:

The quantity and diameter of the cables to be installed, and the desired spare capacity for future additions determine the required space in a cable management system.

Here are some guidelines to determine the space needed for cables.

In the table to the right, an indication of the diameters and required area (in cm²) is given. This is the space that needs to be available in the cable tray or ladder.

When the quantity of each type of cable is known, the total cross section of the cable ladder can easily be calculated .

Example:

When 30 cables 4 x 10 mm² and 10 cables 5 x 35 mm² are foreseen, the required cross section can be calculated as 30 x 3 cm² and 10 x 10 cm² = 190 cm².

Obviously, when large numbers of cables have to be installed, it may be necessary to use more than one ladder in a parallel or multi level configuration.

Type:	diameter (mm)	required cross section (cm ²)	cable weight (N/m)
4 x 1,5	9	1,0	1,3
4 x 2,5	10	1,2	1,7
4 x 4	13	1,6	3,1
4 x 10	17	3,0	6,1
4 x 16	20	4,0	8,9
5 x 25	26	7,0	16,5
5 x 35	30	10,0	21,4
5 x 50	34	12,5	28,6
5 x 70	40	17,0	40,3
5 x 95	45	22,0	55,8

(This table is only for indication, for exact sizes and weights, please consult the cable manufacturer's specifications.)

The practical capacity of cable trays is found by multiplying the height and width (in cm). For cable ladders you have to allow for a slight reduction of cross section due to the space that is taken by the rungs. The images and table below show the inside dimensions and available space inside each type of cable ladder. Example: medium duty ladder H 100 has an internal height of 7 cm.

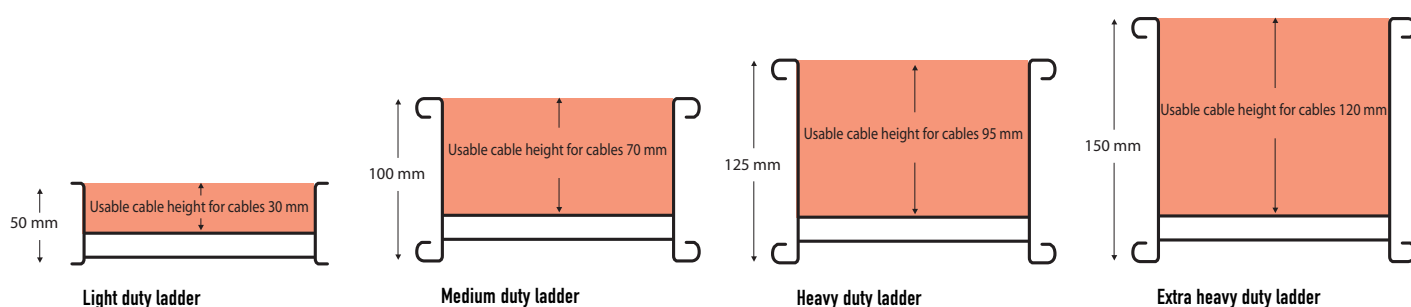

Width	200	300	450	600	750	900
Type						
Light duty	60	90	135			
Medium duty	140	210	315	420		
Heavy duty	190	285	428	570	713	855
Extra heavy duty	240	360	540	720	900	1080

cm² of cable area

■ Cable weight

The load on a cable ladder is a result of the quantity and diameter of the cables. The table above indicates the cross section and the specific weight of some cables types in N per meter. (1 N = 0,1 kg)

Multiplication of all cables and their specific weight will result in the total weight per meter of ladder. In the same example configuration as above:
 30 cables 4 x 10 mm² and 10 cables 5 x 35 mm² =
 $30 \times 6,1 + 10 \times 21,4 \text{ N/m} = 397 \text{ N/m}$

If the quantity and type of cables is not (yet) known, you can apply as a rule of thumb the maximum practical cable weight of 2,5 N/m per cm² of ladder cross section.

Example: a cable ladder with a height of 10 cm and a width of 30 cm, has an internal cross section of $7 \times 30 = 210 \text{ cm}^2$. In this ladder the maximum practical weight of cables will not exceed $210 \times 2,5 \text{ N/m} = 525 \text{ N/m}$.

Loading graphs

Loading graphs industrial ladders

■ Safe working load and support distance (span)

The safe working load (SWL) and maximum support distance (span) for a cable ladder, is determined by the strength of the cable ladder and the total cable weight. The loading graphs show the maximal load in a ladder, the deflexion at a given load and the maximum support distance.

Legrand cable ladders have been tested according to european standard IEC61537, test type 1. This test type reflects the allowed loads under the most unfavourable circumstances. For you as a planner or installer this means maximum safety.

The loading information is always applicable without restrictions or reservations to the installation method. The coupler can be fitted at any given position along the length, and all spans can be equally large.

(However, higher performances can be achieved under certain conditions, please contact your customer service for more information).

The safe working loads presented in the graphs have a safety factor of at least 1,7 against collapse.

The graphs show the safe working load and maximum span for each ladder type, as well as the deflection of the ladder at a given load and span.

Example: Ladder H = 100 mm (so internal height = 7 cm), width 600 mm. According to paragraph 2, we can estimate the practical cable load as:

$$7 \times 60 = 420 \text{ cm}^2 \times 2.5 \text{ N/m} = 1050 \text{ N/m}$$

The loading graph of mediuum duty ladder H = 100 shows, that for a load of 1050 N/m the maximum span is 4,5 meter (green line). At this span and load, the longitudinal deflection of the ladder is about 16 mm.

The IEC 61537 standard allows a maximum longitudinal deflection of 1% of the span, in this case a deflection of 45 mm would have been allowed.



The products of Legrand that fall under the EC harmonisation guideline Low Voltage Directive 93/68/EEC are provided with the CE Marking as proof that they have been developed and produced in accordance with this guideline. A written declaration of conformity for each product or system can be obtained from the manufacturer.

Legrand reserves the right to technically refine, change or improve its products if necessary. The dimensions mentioned in the catalogue can be changed without notice. We advise you to ask for the detailed information at our sales office if dimensions are essential.



■ Cable ladder Light duty H = 50 mm

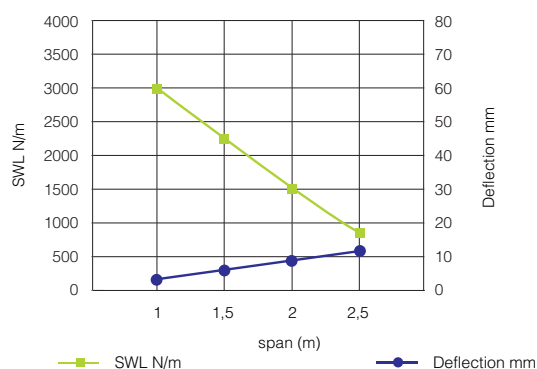

■ Cable ladder Medium duty H = 100 mm

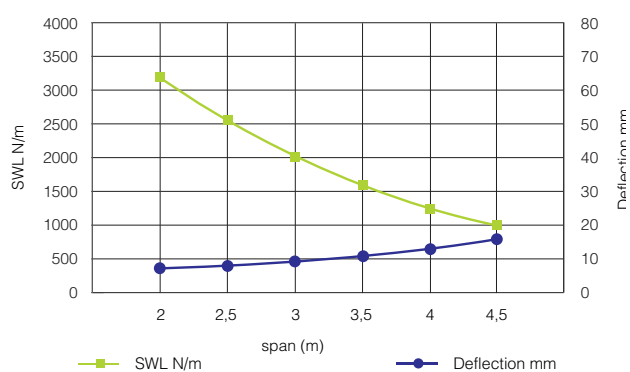

■ Cable ladder Heavy duty H = 125 mm

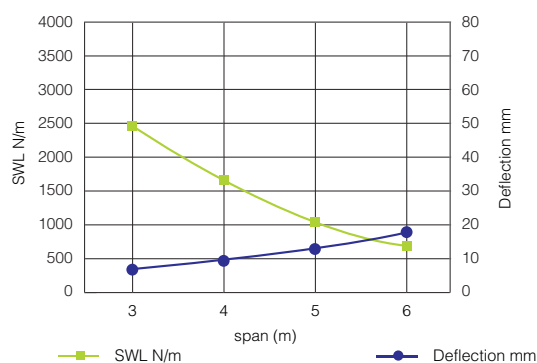

■ Cable ladder Extra heavy duty H = 150 mm

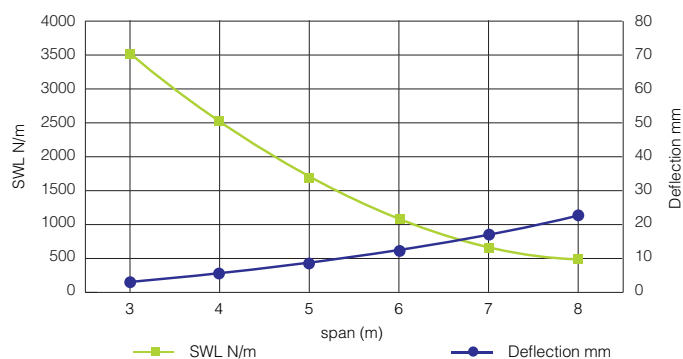

* Heavy duty ladder H 125:
For spans of more than 4,5 meters,
the ladder length of 6 m must be used.









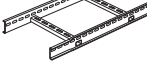

General notes:

- It is not allowed to:
 - Walk across a cable ladder installation
 - Let ladders, scaffolding or other objects lean on a cable ladder installation
- The loads shown in all graphs are the safe recommended maximum loads that can be applied and must include wind, snow and any other external forces in addition to the cable load
- Fittings do not need separate supporting (unless W > 600 mm)

Swifts cable ladder hot dip galvanised

Light duty H = 50 mm

LIGHT DUTY H = 50 mm

LIGHT DUTY H = 50 mm	Width (mm)	LADDER	FITTINGS			
		Straight length  Length 3000 mm	Flat bend 90° 	Inside riser 90° 	Outside riser 90° 	Equal tee 
	200	OL 200 G	OFB 200 90 300 G	OIR 200 90 300 G	OOR 200 90 300 G	OT 200 300R G
	300	OL 300 G	OFB 300 90 300 G	OIR 300 90 300 G	OOR 300 90 300 G	OT 300 300R G
	450	OL 450 G	OFB 450 90 300 G	OIR 450 90 300 G	OOR 450 90 300 G	OT 450 300R G
	Fixing materials	4x  Ref.nr. OFAST G (set of 20) When ladder is cut use: 1x Ref.nr. OC GZ 	8x  Ref.nr. OFAST G (set of 20)	8x  Ref.nr. OFAST G (set of 20)	8x  Ref.nr. OFAST G (set of 20)	12x  Ref.nr. OFAST G (set of 20)

Please note that one item OFAST G consists of 20 fasteners M6 x 16

(1) Only where ladder has been cut to length. When joining a cut length to an uncut length or an accessory only one coupler is required

LIGHT DUTY H = 50 mm



Coupler sets (Straight couplers and fitting to fitting couplers)

Light duty coupling (cut lengths only)

Cut the side rail at the joggle joint 100 mm longer than the required length. Locate the joggle end of a straight length or accessory in the side rail of the cut length and butt join the opposite side rails. Secure the joggle joint. Fit a coupler to the outside of the butt joined side rails across the joint. Adjust the coupler position to align the slots with the side rail slots and secure it with the fastenings.

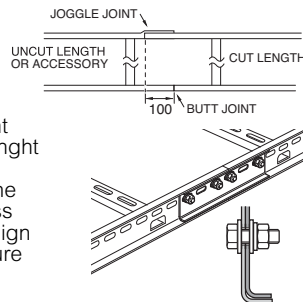

Note: because of integrated coupler the effective length of a light duty cable ladder is 2900 mm

LIGHT DUTY H = 50 mm

ACCESSORIES

Coupler set ⁽¹⁾	Ancillary mounting bracket	Ancillary mounting plate	Straight divider – 3 m	Bendable connectors	Vertical hinged connectors	End cap
OC GZ	OAMB 200 GZ	MP GZ	ODV GX	OH GZ	OV GZ	OEC
OC GZ	OAMB 300 GZ	MP GZ	ODV GX	OH GZ	OV GZ	OEC
OC GZ	OAMB 450 GZ	MP GZ	ODV GX	OH GZ	OV GZ	OEC
SUPPLIED IN PAIRS WITH FASTENERS	SUPPLIED WITH BRACKET TO LADDER FASTENERS	SUPPLIED WITH BRACKET TO LADDER FASTENERS	10x Ref.nr. LFDV G M6	SUPPLIED IN PAIRS WITH FASTENERS	SUPPLIED IN SET WITH FASTENERS	-

Packaging	Ref.no.	Fastenings
1	OFAST G	Supplied in packs to couple five joints Pack consists of: - M6 x 16 set screws 20 off - M6 nuts 20 off - M6 roofing washers 40 off - M6 shakeproof washers 20 off
100	LFDV G M6	Divider fixing set M6



Supports & brackets (page 58)

Swiftrack channel (page 74)

Swifts cable ladder hot dip galvanised

Light duty H = 50 mm

HDG
50

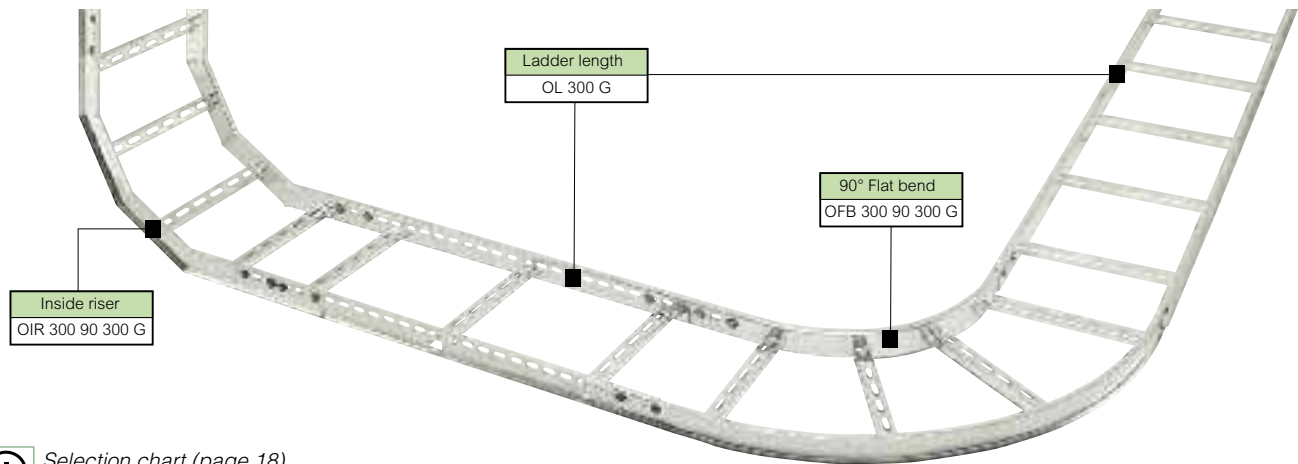

Selection chart (page 18)
Dimensions and technical information (page 52)

Integral couplers on straight lengths and fittings enable joints to be made quickly and easily, thereby reducing installation time
Rung spacing : 300 mm between centres
Standard radius for fittings : 300 mm

Packaging	Ref.no.	Straight length	
1	OL 200 G	Integral couplers, only need fastenings M6 x 16 (OFAST G)	
		Width	Length
1	OL 300 G	200 mm	3000 mm
1	OL 450 G	300 mm	3000 mm
1	OL 450 G	450 mm	3000 mm

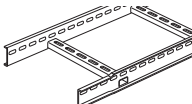

Packaging	Ref.no.	Fittings	
		Integral couplers, only need fastenings M6 x 16 (OFAST G)	
		Flat bend 90°	
		Width	
1	OFB 200 90 300 G	200 mm	
1	OFB 300 90 300 G	300 mm	
1	OFB 450 90 300 G	450 mm	
		Inside riser 90°	
		Width	
1	OIR 200 90 300 G	200 mm	
1	OIR 300 90 300 G	300 mm	
1	OIR 450 90 300 G	450 mm	
		Outside riser 90°	
		Width	
1	OOR 200 90 300 G	200 mm	
1	OOR 300 90 300 G	300 mm	
1	OOR 450 90 300 G	450 mm	
		Equal tee	
		Width	
1	OT 200 300R G	200 mm	
1	OT 300 300R G	300 mm	
1	OT 450 300R G	450 mm	

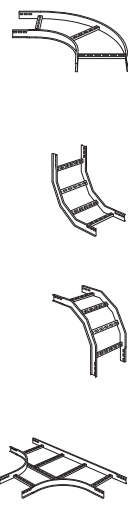

Packaging	Ref.no.
1	OC GZ
1	OAMB 200 GZ
1	OAMB 300 GZ
1	OAMB 450 GZ
1	MP GZ
1	ODV GX
1	OH GZ

Accessories

Coupler set

Supplied in pairs with fastenings
Required only where ladder has been cut to length.
When joining a cut length to an uncut length or an accessory only one coupler is required

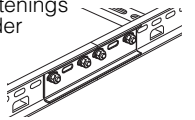

Ancillary mounting bracket

Supplied singly with bracket to ladder fasteners

Width
200 mm
300 mm
450 mm

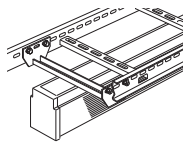

Ancillary mounting plate

Supplied singly with bracket to ladder fasteners

For rung mounting or side rail mounting

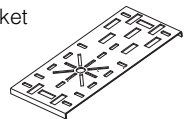

Straight divider – 3 m

To be fixed with 10 fixings M6 (ref.no. LFDV G M6)

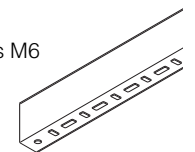

Bendable connectors

Supplied in pairs with fasteners
For fabricating accessories on site to make up bends, reducers and compensate for misalignment of straight lengths

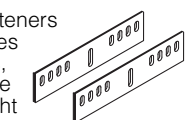



Swifts cable ladder hot dip galvanised

Light duty H = 50 mm *(continued)*

HDG
50

Packaging Ref.no. Accessories *(continued)*

1	OV GZ	Vertical hinged connectors Supplied in sets comprising four plates and fasteners Use with straight lengths to form risers or solve minor misalignment problems on site	
10	OEC	End cap Material: plastic	

1	OFAST G	Fastenings Supplied in packs to couple five joints Pack consists of: - M6 x 16 set screws 20 off - M6 nuts 20 off - M6 roofing washers 40 off - M6 shakeproof washers 20 off	
100	LFDV G M6	Divider fixing set M6	

Supports & brackets (page 58)

Swiftrack channel (page 74)

CABLE LADDER

Light duty ladder, light, strong & well protected

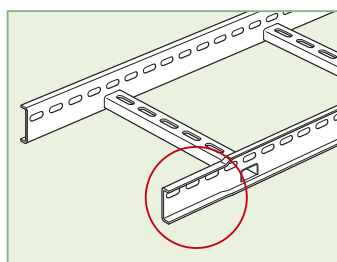

■ Integral coupler on straight lengths

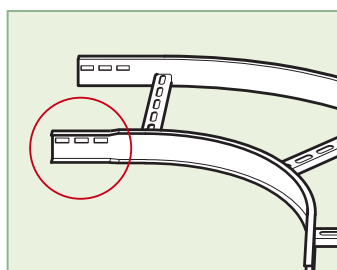

■ Integral coupler on all fittings

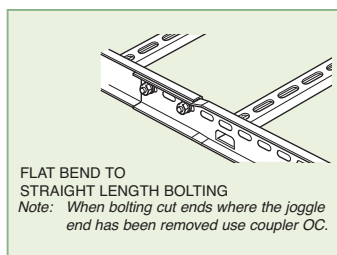

■ Coupling detail

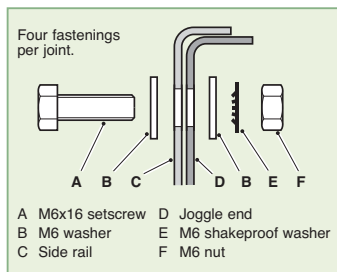

■ Only one set of fasteners fits all

Width (mm)	Length (mm)	Weight (kg/pc)
200	3000	5,3
300	3000	5,7
450	3000	7,0

■ Light to handle

Swifts cable ladder hot dip galvanised

Medium duty H = 100 mm

MEDIUM DUTY H = 100 mm

Width (mm)	LADDER		FITTINGS					Inside riser 90°
	Straight length	Cover straight length	Flat bend 45°	Cover flat bend 45°	Flat bend 90°	Cover flat bend 90°		
	Length 3000 mm							
200	ZL 200 G	CV 200 GX	ZFB 200 45 300 G	FBCV 200 45 300 GX	ZFB 200 90 300 G	FBCV 200 90 300 GX	ZIR 200 90 300 G	
300	ZL 300 G	CV 300 GX	ZFB 300 45 300 G	FBCV 300 45 300 GX	ZFB 300 90 300 G	FBCV 300 90 300 GX	ZIR 300 90 300 G	
450	ZL 450 G	CV 450 GX	ZFB 450 45 300 G	FBCV 450 45 300 GX	ZFB 450 90 300 G	FBCV 450 90 300 GX	ZIR 450 90 300 G	
600	ZL 600 G	CV 600 GX	ZFB 600 45 300 G	FBCV 600 45 300 GX	ZFB 600 90 300 G	FBCV 600 90 300 GX	ZIR 600 90 300 G	
Fixing materials	1x set Ref.nr. ZC GZ	4x LFCC G M8 600 mm: + 4x LFCOV G M6	8x Ref.nr. LF G M10	5x LFCC G M8 600 mm: + 4x LFCOV G M6	8x Ref.nr. LF G M10	5x LFCC G M8 600 mm: + 4x LFCOV G M6	8x Ref.nr. LF G M10	

MEDIUM DUTY H = 100 mm

Width (mm)	ACCESSORIES						
	Straight couplers	Fitting to fitting couplers	Bendable connectors	Straight divider 3 m	Cover fixing set	Flexible expansion couplers	Vertical hinged connectors
	Length 3000 mm						
200	ZC GZ	ZFC GZ	ZH GZ	ZDV GX	LFCC G M8	ZE GZ	ZV GZ
300	ZC GZ	ZFC GZ	ZH GZ	ZDV GX	LFCC G M8	ZE GZ	ZV GZ
450	ZC GZ	ZFC GZ	ZH GZ	ZDV GX	LFCC G M8	ZE GZ	ZV GZ
600	ZC GZ	ZFC GZ	ZH GZ	ZDV GX	LFCC G M8	ZE GZ	ZV GZ
Fixing materials	SUPPLIED IN PAIRS WITH FASTENERS	SUPPLIED IN PAIRS WITH FASTENERS	SUPPLIED IN PAIRS WITH FASTENERS	10x Ref.nr. LFDV G M6	WITH FASTENERS	SUPPLIED IN PAIRS WITH FASTENERS	SUPPLIED IN PAIRS WITH FASTENERS

MEDIUM DUTY H = 100 mm



MEDIUM DUTY H = 100 mm
FITTINGS

Cover inside riser 90°	Outside riser 90°	Cover outside riser 90°	Equal tee	Cover equal tee	Branch piece	Cover branch piece
ZIRC 200 90 300 GX	ZOR 200 90 300 G	ZORC 200 90 300 GX	ZT 200 300R G	TCV 200 300R GX	ZB 200 300R G	BCV 200 300R GX
ZIRC 300 90 300 GX	ZOR 300 90 300 G	ZORC 300 90 300 GX	ZT 300 300R G	TCV 300 300R GX	ZB 300 300R G	BCV 300 300R GX
ZIRC 450 90 300 GX	ZOR 450 90 300 G	ZORC 450 90 300 GX	ZT 450 300R G	TCV 450 300R GX	ZB 450 300R G	BCV 450 300R GX
ZIRC 600 90 300 GX	ZOR 600 90 300 G	ZORC 600 90 300 GX	ZT 600 300R G	TCV 600 300R GX	ZB 600 300R G	BCV 600 300R GX
4x LFCC G M8 600 mm: + 4x LFCOV G M6	8x Ref.nr. LF G M10	4x LFCC G M8 600 mm: + 4x LFCOV G M6	12x Ref.nr. LF G M10	7x LFCC G M8 600 mm: + 4x LFCOV G M6	8x Ref.nr. LF G M10	4x LFCC G M8 600 mm: + 4x LFCOV G M6

MEDIUM DUTY H = 100 mm
ACCESSORIES

Articulated riser	Dropout plate	Short reducer bracket	Ancillary mounting bracket	Ancillary mounting plate	Tee brackets	End cap	Rail-to-rail dropout brackets	Earth continuity connector
ZAR 200 GZ	DO 200 GZ	ZR 50 GZ ⁽¹⁾	AMB 200 GZ	MP GZ	ZTB GZ	ZEC	M GZ	PLFEB
ZAR 300 GZ	DO 300 GZ	ZR 75 GZ ⁽¹⁾	AMB 300 GZ	MP GZ	ZTB GZ	ZEC	M GZ	PLFEB
ZAR 450 GZ	DO 450 GZ	ZR 100 GZ ⁽¹⁾	AMB 450 GZ	MP GZ	ZTB GZ	ZEC	M GZ	PLFEB
ZAR 600 GZ	DO 600 GZ	ZR 150 GZ ⁽¹⁾	AMB 600 GZ	MP GZ	ZTB GZ	ZEC	M GZ	PLFEB
SUPPLIED IN SET WITH FASTENERS	WITH FASTENERS	WITH FASTENERS	SUPPLIED WITH BRACKET TO LADDER FASTENERS	SUPPLIED WITH BRACKET TO LADDER FASTENERS	SUPPLIED IN PAIRS WITH FASTENERS	-	SUPPLIED IN PAIRS WITH FASTENERS	WITH FASTENERS

(1) Short reducer bracket

Supplied singly with fasteners
 Use to form a reducer on site
 Straight reducer – use in pairs
 Offset reducer – use singly with straight coupler
 To calculate (Y) for straight reducers and offset reducers

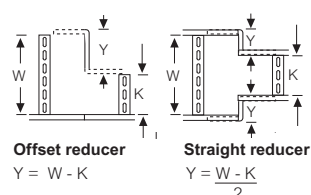

W = main ladder mm
 K = reduced ladder mm

Packaging	Ref.no.	Fastenings
50	LF G M10	Fixing set M10 x 20
30	LFCC G M8	Cover fixing set M8
50	LFCOV G M6	Overlap fixing set M6
100	LFDV G M6	Divider fixing set M6



Supports & brackets (page 58)

Swiftrack channel (page 74)

Swifts cable ladder hot dip galvanised

Medium duty H = 100 mm

HDG
SSS
100

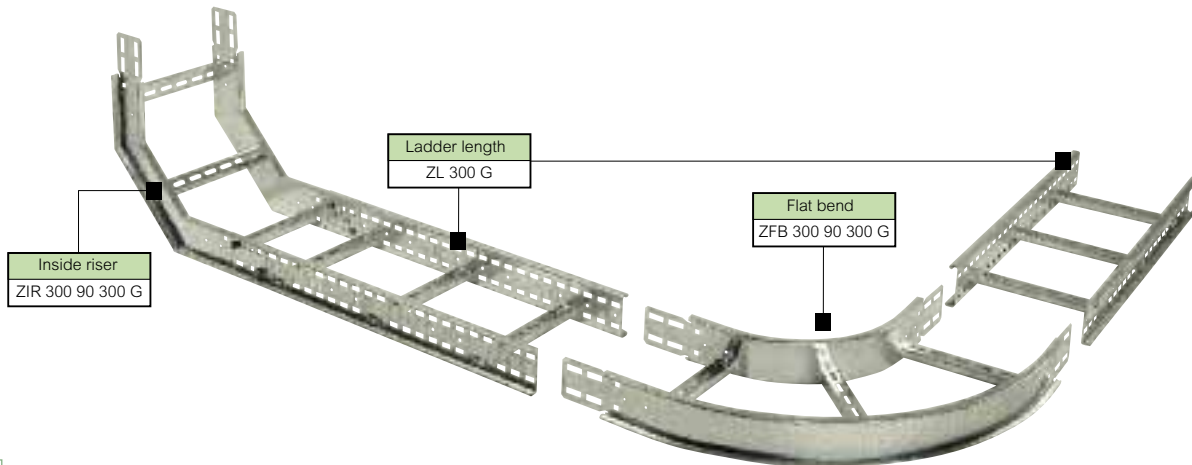

Selection chart (page 22)
Dimensions and technical information (page 52)

When connecting fittings to straight lengths, use fastener sets (see below)

Rung spacing : 300 mm between centres
Standard radius for fittings : 300 mm



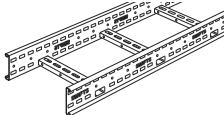

Packaging	Ref.no.	Straight length	
1	ZL 200 G	Width 200 mm	Length 3000 mm
1	ZL 300 G	300 mm	3000 mm
1	ZL 450 G	450 mm	3000 mm
1	ZL 600 G	600 mm	3000 mm



Packaging	Ref.no.	Cover straight length	
To be fixed with 4 Cover fixing sets (ref.no. LFCC G M8)			
1	CV 200 GX	Width 200 mm	Length 3000 mm
1	CV 300 GX	300 mm	3000 mm
1	CV 450 GX	450 mm	3000 mm
1	CV 600 GX	600 mm	3000 mm ⁽¹⁾



Packaging	Ref.no.	Fittings
Flat bend 45°		
To be fixed with 8 fixing sets (ref.no. LF G M10)		
Width		
1	ZFB 200 45 300 G	200 mm
1	ZFB 300 45 300 G	300 mm
1	ZFB 450 45 300 G	450 mm
1	ZFB 600 45 300 G	600 mm
Cover flat bend 45°		
To be fixed with 5 Cover fixing sets (ref.no. LFCC G M8)		
1	FBCV 200 45 300 GX	200 mm
1	FBCV 300 45 300 GX	300 mm
1	FBCV 450 45 300 GX	450 mm
1	FBCV 600 45 300 GX	600 mm ⁽¹⁾
Flat bend 90°		
To be fixed with 8 fixing sets (ref.no. LF G M10)		
1	ZFB 200 90 300 G	200 mm
1	ZFB 300 90 300 G	300 mm
1	ZFB 450 90 300 G	450 mm
1	ZFB 600 90 300 G	600 mm
Cover flat bend 90°		
To be fixed with 5 Cover fixing sets (ref.no. LFCC G M8)		
1	FBCV 200 90 300 GX	200 mm
1	FBCV 300 90 300 GX	300 mm
1	FBCV 450 90 300 GX	450 mm
1	FBCV 600 90 300 GX	600 mm ⁽¹⁾

(1) Interlock 600 mm wide covers with 4 fixings M6 (ref.no. LFCCOV G M6) per joint for additional stability

Swifts cable ladder hot dip galvanised

Medium duty H = 100 mm *(continued)*

HDG
SSS
100



Packaging	Ref.no.	Fittings <i>(continued)</i>
		Inside riser 90° To be fixed with 8 fixing sets (ref.no. LF G M10)
		Width
1	ZIR 200 90 300 G	200 mm
1	ZIR 300 90 300 G	300 mm
1	ZIR 450 90 300 G	450 mm
1	ZIR 600 90 300 G	600 mm
		Cover inside riser 90° To be fixed with 4 Cover fixing sets (ref.no. LFCC G M8)
		Width
1	ZIRC 200 90 300 GX	200 mm
1	ZIRC 300 90 300 GX	300 mm
1	ZIRC 450 90 300 GX	450 mm
1	ZIRC 600 90 300 GX	600 mm ⁽¹⁾
		Outside riser 90° To be fixed with 8 fixing sets (ref.no. LF G M10)
		Width
1	ZOR 200 90 300 G	200 mm
1	ZOR 300 90 300 G	300 mm
1	ZOR 450 90 300 G	450 mm
1	ZOR 600 90 300 G	600 mm
		Cover outside riser 90° To be fixed with 4 Cover fixing sets (ref.no. LFCC G M8)
		Width
1	ZORC 200 90 300 GX	200 mm
1	ZORC 300 90 300 GX	300 mm
1	ZORC 450 90 300 GX	450 mm
1	ZORC 600 90 300 GX	600 mm ⁽¹⁾





Packaging	Ref.no.	Fittings <i>(continued)</i>
		Equal tee To be fixed with 12 fixing sets (ref.no. LF G M10)
		Width
1	ZT 200 300R G	200 mm
1	ZT 300 300R G	300 mm
1	ZT 450 300R G	450 mm
1	ZT 600 300R G	600 mm
		Cover equal tee To be fixed with 7 Cover fixing sets (ref.no. LFCC G M8)
		Width
1	TCV 200 300R GX	200 mm
1	TCV 300 300R GX	300 mm
1	TCV 450 300R GX	450 mm
1	TCV 600 300R GX	600 mm ⁽¹⁾
		Branch piece To be fixed with 8 fixing sets (ref.no. LF G M10)
		Width
1	ZB 200 300R G	200 mm
1	ZB 300 300R G	300 mm
1	ZB 450 300R G	450 mm
1	ZB 600 300R G	600 mm
		Cover branch piece To be fixed with 4 Cover fixing sets (ref.no. LFCC G M8)
		Width
1	BCV 200 300R GX	200 mm
1	BCV 300 300R GX	300 mm
1	BCV 450 300R GX	450 mm
1	BCV 600 300R GX	600 mm ⁽¹⁾

(1) Interlock 600 mm wide covers with 4 fixings M6 (ref.no. LFCCOV G M6) per joint for additional stability

Swifts cable ladder hot dip galvanised

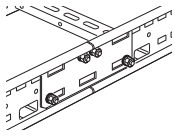
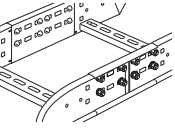
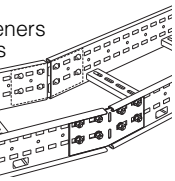
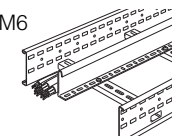
Medium duty H = 100 mm

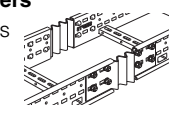
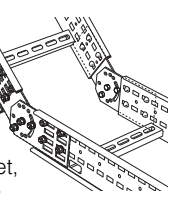
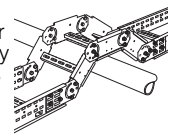
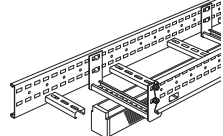
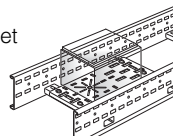
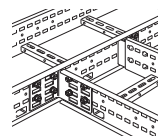

Packaging	Ref.no.	Accessories	Packaging	Ref.no.	Accessories (continued)
1	ZC GZ	Straight couplers Supplied in pairs, with fasteners (4 per coupler) Use to couple straight lengths to straight lengths 	1	DO 200 GZ	Dropout plate Supplied with fasteners Use to provide local support for cables as they exit a cable ladder run between rungs Width 200 mm
1	ZFC GZ	Fitting to fitting couplers Supplied in pairs, with fasteners (4 per coupler) Use to couple fitting to fitting 	1	DO 300 GZ	200 mm
1	ZH GZ	Bendable connectors Supplied in pairs with fasteners For fabricating accessories on site to make up bends, reducers and compensate for misalignment of straight lengths 	1	DO 450 GZ	300 mm
1	ZDV GX	Straight divider – 3 m To be fixed with 10 fixings M6 (ref.no. LFDV G M6) 	1	DO 600 GZ	450 mm
30	LFCC G M8	Cover fixing set Including fasteners 	1	ZR 50 GZ	600 mm
1	ZE GZ	Flexible expansion couplers Pair supplied with fasteners 	1	ZR 75 GZ	Short reducer bracket Supplied singly with fasteners Use to form a reducer on site Straight reducer – use in pairs Offset reducer – use singly with straight coupler To calculate (Y) for straight reducers and offset reducers Width Height 50 mm 100 mm
1	ZV GZ	Vertical hinged connectors Supplied in sets comprising four plates and fasteners Use with straight lengths to form risers or solve minor misalignment problems on site When used with tee bracket, vertical hinged connectors can offset tee branch 	1	ZR 100 GZ	75 mm 100 mm
1	ZAR 200 GZ	Articulated riser Set comprises three ladder sections and the necessary vertical hinged connectors with fasteners Use to form risers or solve most misalignment problems on site Width Height 200 mm 100 mm 	1	ZR 150 GZ	100 mm 100 mm
1	ZAR 300 GZ		1	AMB 200 GZ	Ancillary mounting bracket Supplied singly with bracket to ladder fasteners Width 200 mm 
1	ZAR 450 GZ		1	AMB 300 GZ	300 mm
1	ZAR 600 GZ		1	AMB 450 GZ	450 mm
			1	AMB 600 GZ	600 mm
			1	MP GZ	Ancillary mounting plate Supplied singly with bracket to ladder fasteners For rung mounting or side rail mounting 
			1	ZTB GZ	Tee brackets Supplied in pairs with fasteners 
			10	ZEC	End cap Material: plastic 

Swifts cable ladder





hot dip galvanised

Medium duty H = 100 mm

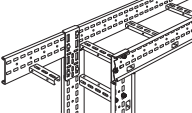
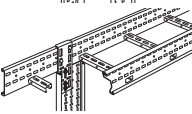
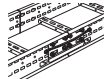

Swifts cable ladder

technical information

Packaging	Ref.no.	Accessories <i>(continued)</i>
1	M GZ	Rail-to-rail dropout brackets Supplied in pairs with fastenings Use to attach a vertical run of ladder or tray beneath a horizontal main ladder run For ladder to ladder connection  or Tray to ladder connection 
10	PLFEB	Earth continuity connector Including fasteners Conductor area: 16 mm ² 
Fastenings		
50	LF G M10	Fixing set M10 x 20 
30	LFCC G M8	Cover fixing set M8 
50	LFCOV G M6	Overlap fixing set M6 
100	LFDV G M6	Divider fixing set M6 

Supports & brackets (page 58)

Swiftrack channel (page 74)

■ Coupler sets Medium duty (Straight couplers and fitting to fitting couplers)

Supplied in pairs, with fasteners (4 per coupler)
 Fastener positioning : common to both coupler set types



Note : when connecting straight lengths to straight lengths even when ladder is cut to length, the slots in the coupler will always align with slots in the ladder side rail.
 When bolting to cut ends adjust coupler to ensure 4 bolts can be inserted

■ Fastener position

Connecting fittings with integral coupler to straight lengths

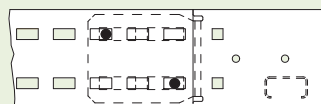

■ Tee brackets

Supplied in pairs with fasteners
 Use to create a straight or 90° branch off a straight ladder run

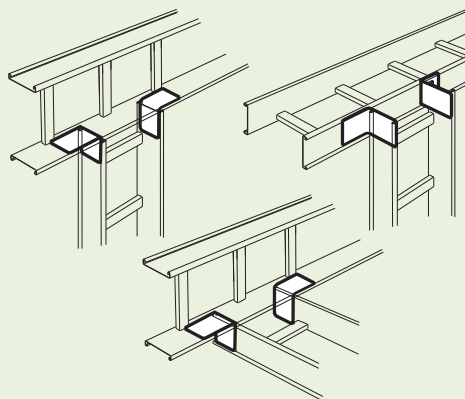

Couple with vertical hinged connectors or bendable connectors to offset the branch

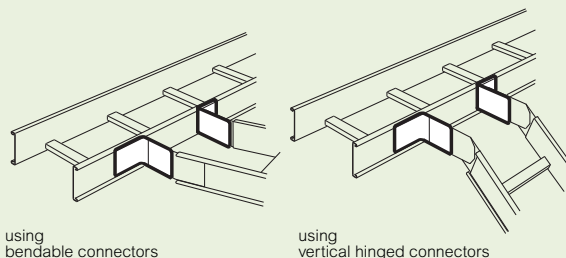

using bendable connectors









using vertical hinged connectors

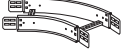

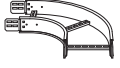

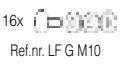

Main ladder run	Permitted ladder branch		
	Medium duty	Heavy duty	Extra heavy duty
Medium duty H = 100 mm	ZTB	–	–
Heavy duty H = 125 mm	ZTB	PTB	–
Extra heavy duty H = 150 mm	ZTB	PTB	ETB

Swifts cable ladder hot dip galvanised

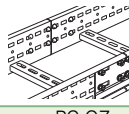
Heavy duty H = 125 mm

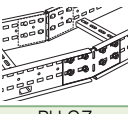
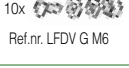
HEAVY DUTY H = 125 mm

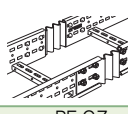
Width (mm)	LADDER			FITTINGS			
	Straight length		Cover straight length	Flat bend 45°	Cover flat bend 45°	Flat bend 90°	Cover flat bend 90°
	Length 3000 mm	Length 6000 mm	Length 3000 mm				
200	PL 200 G	PL 200 G 6M	CV 200 GX	PFB 200 45 300 G	FBCV 200 45 300 GX	PFB 200 90 300 G	FBCV 200 90 300 GX
300	PL 300 G	PL 300 G 6M	CV 300 GX	PFB 300 45 300 G	FBCV 300 45 300 GX	PFB 300 90 300 G	FBCV 300 90 300 GX
450	PL 450 G	PL 450 G 6M	CV 450 GX	PFB 450 45 300 G	FBCV 450 45 300 GX	PFB 450 90 300 G	FBCV 450 90 300 GX
600	PL 600 G	PL 600 G 6M	CV 600 GX	PFB 600 45 300 G	FBCV 600 45 300 GX	PFB 600 90 300 G	FBCV 600 90 300 GX
750	PL 750 G	PL 750 G 6M	CV 750 GX	PFB 750 45 300 G	FBCV 750 45 300 GX	PFB 750 90 300 G	FBCV 750 90 300 GX
900	PL 900 G	PL 900 G 6M	CV 900 GX	PFB 900 45 300 G	FBCV 900 45 300 GX	PFB 900 90 300 G	FBCV 900 90 300 GX
Fixing materials	1x set  Ref.nr. PC GZ	1x set  Ref.nr. PC GZ	4x LFCC G M8 600 - 900 mm: + 4x LFCCOV G M6 750 mm: + 2x CVSTIFF 750 G 900 mm: + 2x CVSTIFF 900 G	16x  Ref.nr. LF G M10	5x LFCC G M8 600 - 900 mm: + 4x LFCCOV G M6 750 mm: + 2x CVSTIFF 750 G 900 mm: + 2x CVSTIFF 900 G	16x  Ref.nr. LF G M10	5x LFCC G M8 600 - 900 mm: + 4x LFCCOV G M6 750 mm: + 2x CVSTIFF 750 G 900 mm: + 2x CVSTIFF 900 G

HEAVY DUTY H = 125 mm							
ACCESSORIES							
Width (mm)	Straight couplers	Fitting to fitting couplers	Bendable connectors	Straight divider 3 m	Cover fixing set	Flexible expansion couplers	Vertical hinged connectors
200	PC GZ	PFC GZ	PH GZ	PDV GX	LFCC G M8	PE GZ	PV GZ
300	PC GZ	PFC GZ	PH GZ	PDV GX	LFCC G M8	PE GZ	PV GZ
450	PC GZ	PFC GZ	PH GZ	PDV GX	LFCC G M8	PE GZ	PV GZ
600	PC GZ	PFC GZ	PH GZ	PDV GX	LFCC G M8	PE GZ	PV GZ
750	PC GZ	PFC GZ	PH GZ	PDV GX	LFCC G M8	PE GZ	PV GZ
900	PC GZ	PFC GZ	PH GZ	PDV GX	LFCC G M8	PE GZ	PV GZ
Fixing materials	 SUPPLIED IN PAIRS WITH FASTENERS	 SUPPLIED IN PAIRS WITH FASTENERS	 SUPPLIED IN PAIRS WITH FASTENERS	10x  Ref.nr. LFDV G M6	 WITH FASTENERS	 SUPPLIED IN PAIRS WITH FASTENERS	 SUPPLIED IN PAIRS WITH FASTENERS

HEAVY DUTY H = 125 mm

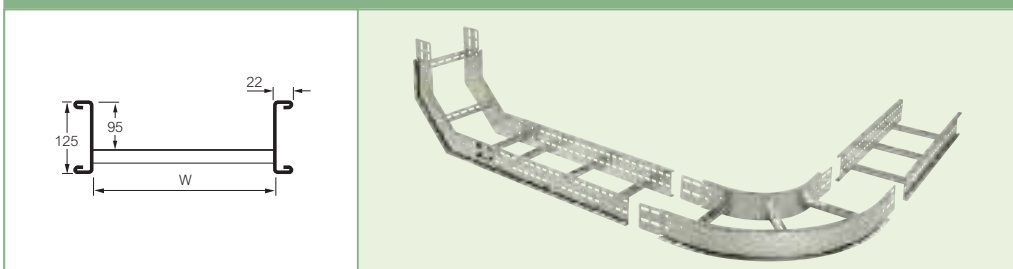

HEAVY DUTY H = 125 mm
FITTINGS

Inside riser 90°	Cover inside riser 90°	Outside riser 90°	Cover outside riser 90°	Equal tee	Cover equal tee	Branch piece	Cover branch piece
PIR 200 90 300 G	PIRC 200 90 300 GX	POR 200 90 300 G	PORC 200 90 300 GX	PT 200 300R G	TCV 200 300R GX	PB 200 300R G	BCV 200 300R GX
PIR 300 90 300 G	PIRC 300 90 300 GX	POR 300 90 300 G	PORC 300 90 300 GX	PT 300 300R G	TCV 300 300R GX	PB 300 300R G	BCV 300 300R GX
PIR 450 90 300 G	PIRC 450 90 300 GX	POR 450 90 300 G	PORC 450 90 300 GX	PT 450 300R G	TCV 450 300R GX	PB 450 300R G	BCV 450 300R GX
PIR 600 90 300 G	PIRC 600 90 300 GX	POR 600 90 300 G	PORC 600 90 300 GX	PT 600 300R G	TCV 600 300R GX	PB 600 300R G	BCV 600 300R GX
PIR 750 90 300 G	PIRC 750 90 300 GX	POR 750 90 300 G	PORC 750 90 300 GX	PT 750 300R G	TCV 750 300R GX	PB 750 300R G	BCV 750 300R GX
PIR 900 90 300 G	PIRC 900 90 300 GX	POR 900 90 300 G	PORC 900 90 300 GX	PT 900 300R G	TCV 900 300R GX	PB 900 300R G	BCV 900 300R GX
16x Ref.nr. LF G M10	4x LFCC G M8 600 - 900 mm: + 4x LFCOV G M6 750 mm: + 2x CVSTIFF 750 G 900 mm: + 2x CVSTIFF 900 G	16x Ref.nr. LF G M10	4x LFCC G M8 600 - 900 mm: + 4x LFCOV G M6 750 mm: + 2x CVSTIFF 750 G 900 mm: + 2x CVSTIFF 900 G	24x Ref.nr. LF G M10	7x LFCC G M8 600 - 900 mm: + 4x LFCOV G M6 750 mm: + 3x CVSTIFF 750 G 900 mm: + 3x CVSTIFF 900 G	16x Ref.nr. LF G M10	4x LFCC G M8 600 - 900 mm: + 4x LFCOV G M6 750 mm: + 1x CVSTIFF 750 G 900 mm: + 1x CVSTIFF 900 G

HEAVY DUTY H = 125 mm
ACCESSORIES

Articulated riser	Dropout plate	Short reducer bracket	Ancillary mounting bracket	Ancillary mounting plate	Tee brackets	End cap	Rail-to-rail dropout bracket	Earth continuity connector
PAR 200 GZ	DO 200 GZ	PR 50 GZ ⁽¹⁾ PR 75 GZ ⁽¹⁾ PR 100 GZ ⁽¹⁾ PR 150 GZ ⁽¹⁾	AMB 200 GZ	MP GZ	PTB GZ	PEC	M GZ	PLFEB
PAR 300 GZ	DO 300 GZ		AMB 300 GZ	MP GZ	PTB GZ	PEC	M GZ	PLFEB
PAR 450 GZ	DO 450 GZ		AMB 450 GZ	MP GZ	PTB GZ	PEC	M GZ	PLFEB
PAR 600 GZ	DO 600 GZ		AMB 600 GZ	MP GZ	PTB GZ	PEC	M GZ	PLFEB
PAR 750 GZ	DO 750 GZ		AMB 750 GZ	MP GZ	PTB GZ	PEC	M GZ	PLFEB
PAR 900 GZ	DO 900 GZ		AMB 900 GZ	MP GZ	PTB GZ	PEC	M GZ	PLFEB
SUPPLIED IN SET WITH FASTENERS	WITH FASTENERS	WITH FASTENERS	SUPPLIED WITH BRACKET TO LADDER FASTENERS	SUPPLIED WITH BRACKET TO LADDER FASTENERS	SUPPLIED IN PAIRS WITH FASTENERS		SUPPLIED IN PAIRS WITH FASTENERS	WITH FASTENERS

(1) Short reducer bracket

Supplied singly with fasteners
Use to form a reducer on site
Straight reducer – use in pairs
Offset reducer – use singly with straight coupler
To calculate (Y) for straight reducers and offset reducers

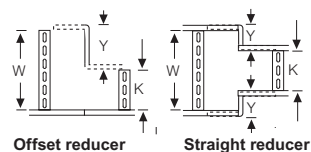
Offset reducer

$$Y = W - K$$

Straight reducer

$$Y = \frac{W - K}{2}$$

W = main ladder mm
K = reduced ladder mm

Packaging	Ref.no.	Fastenings	
50	LF G M10	Fixing set M10 x 20	
30	LFCC G M8	Cover fixing set M8	
50	LFCOV G M6	Overlap fixing set M6	
100	LFDV G M6	Divider fixing set M6	
1	CVSTIFF 750 G	Cover stiffener for covers Width 750 mm	
1	CVSTIFF 900 G	900 mm	

Supports & brackets (page 58)

Swiftrack channel (page 74)

Swifts cable ladder hot dip galvanised

Heavy duty H = 125 mm

HDG
SSS
125

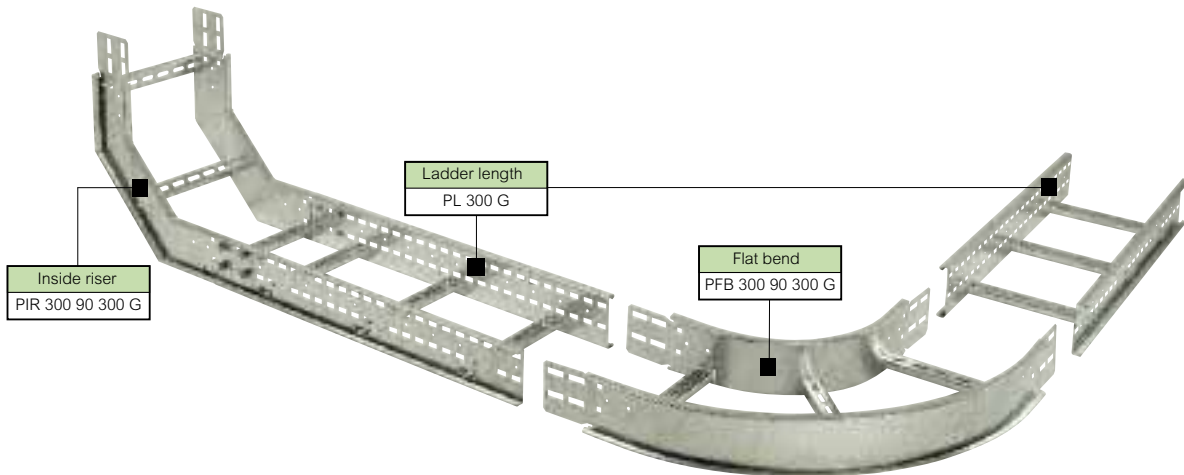

Selection chart (page 28)
Dimensions and technical information (page 52)

When connecting fittings to straight lengths, use fastener sets (see below)

Rung spacing : 300 mm between centres
Standard radius for fittings : 300 mm

Packaging	Ref.no.	Straight length	
		Width	Length
1	PL 200 G	200 mm	3000 mm
1	PL 300 G	300 mm	3000 mm
1	PL 450 G	450 mm	3000 mm
1	PL 600 G	600 mm	3000 mm
1	PL 750 G	750 mm	3000 mm
1	PL 900 G	900 mm	3000 mm
1	PL 200 G 6M	200 mm	6000 mm
1	PL 300 G 6M	300 mm	6000 mm
1	PL 450 G 6M	450 mm	6000 mm
1	PL 600 G 6M	600 mm	6000 mm
1	PL 750 G 6M	750 mm	6000 mm
1	PL 900 G 6M	900 mm	6000 mm

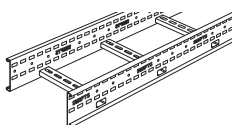





Packaging	Ref.no.	Cover straight length	
		Width	Length
1	CV 200 GX	200 mm	3000 mm
1	CV 300 GX	300 mm	3000 mm
1	CV 450 GX	450 mm	3000 mm
1	CV 600 GX	600 mm	3000 mm ⁽¹⁾
1	CV 750 GX	750 mm	3000 mm ⁽¹⁾⁽²⁾
1	CV 900 GX	900 mm	3000 mm ⁽¹⁾⁽²⁾

To be fixed with 4 Cover fixing sets (ref.no. LFCC G M8)

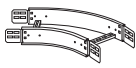

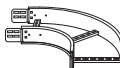
Packaging	Ref.no.	Fittings
		Flat bend 45°
		To be fixed with 16 fixing sets (ref.no. LF G M10)
		Width
1	PFB 200 45 300 G	200 mm
1	PFB 300 45 300 G	300 mm
1	PFB 450 45 300 G	450 mm
1	PFB 600 45 300 G	600 mm
1	PFB 750 45 300 G	750 mm
1	PFB 900 45 300 G	900 mm
		Cover flat bend 45°
		To be fixed with 5 Cover fixing sets (ref.no. LFCC G M8)
1	FBCV 200 45 300 GX	200 mm
1	FBCV 300 45 300 GX	300 mm
1	FBCV 450 45 300 GX	450 mm
1	FBCV 600 45 300 GX	600 mm ⁽¹⁾
1	FBCV 750 45 300 GX	750 mm ⁽¹⁾⁽²⁾
1	FBCV 900 45 300 GX	900 mm ⁽¹⁾⁽²⁾
		Flat bend 90°
		To be fixed with 16 fixing sets (ref.no. LF G M10)
1	PFB 200 90 300 G	200 mm
1	PFB 300 90 300 G	300 mm
1	PFB 450 90 300 G	450 mm
1	PFB 600 90 300 G	600 mm
1	PFB 750 90 300 G	750 mm
1	PFB 900 90 300 G	900 mm
		Cover flat bend 90°
		To be fixed with 5 Cover fixing sets (ref.no. LFCC G M8)
1	FBCV 200 90 300 GX	200 mm
1	FBCV 300 90 300 GX	300 mm
1	FBCV 450 90 300 GX	450 mm
1	FBCV 600 90 300 GX	600 mm ⁽¹⁾
1	FBCV 750 90 300 GX	750 mm ⁽¹⁾⁽²⁾
1	FBCV 900 90 300 GX	900 mm ⁽¹⁾⁽²⁾







(1) Interlock 600, 750 and 900 mm wide covers with 4 fixings M6 (ref.no. LFCCOV G M6) per joint for additional stability
(2) For covers 750 and 900 mm wide, use cover stiffeners CVSTIFF for extra rigidity

Swifts cable ladder hot dip galvanised

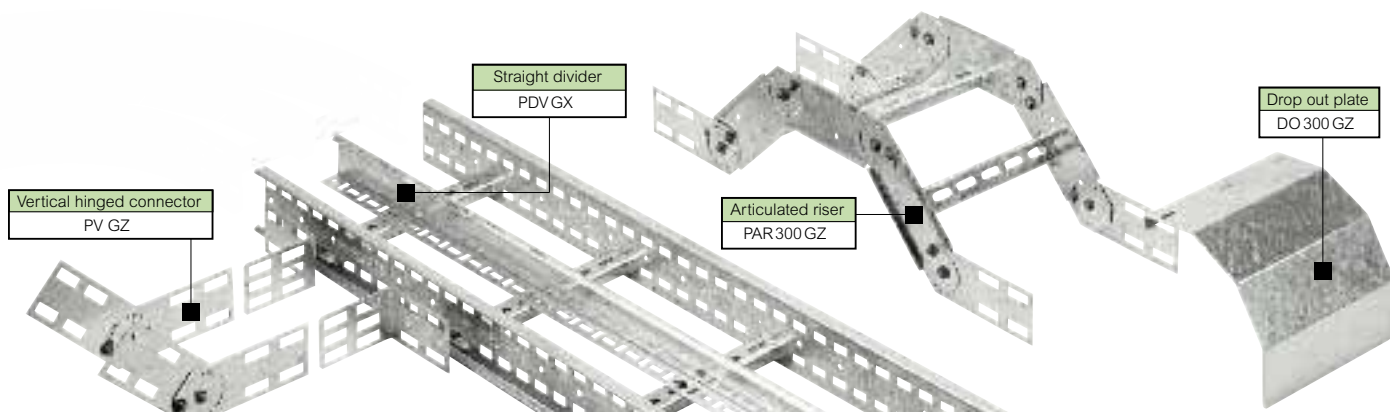
Heavy duty H = 125 mm *(continued)*

HDG
SSS
125



Packaging	Ref.no.	Fittings <i>(continued)</i>
		Inside riser 90° To be fixed with 16 fixing sets (ref.no. LF G M10) Width
1	PIR 200 90 300 G	200 mm
1	PIR 300 90 300 G	300 mm
1	PIR 450 90 300 G	450 mm
1	PIR 600 90 300 G	600 mm
1	PIR 750 90 300 G	750 mm
1	PIR 900 90 300 G	900 mm
		Cover inside riser 90° To be fixed with 4 Cover fixing sets (ref.no. LFCC G M8)
1	PIRC 200 90 300 GX	200 mm
1	PIRC 300 90 300 GX	300 mm
1	PIRC 450 90 300 GX	450 mm
1	PIRC 600 90 300 GX	600 mm ⁽¹⁾
1	PIRC 750 90 300 GX	750 mm ⁽¹⁾⁽²⁾
1	PIRC 900 90 300 GX	900 mm ⁽¹⁾⁽²⁾
		Outside riser 90° To be fixed with 16 fixing sets (ref.no. LF G M10)
1	POR 200 90 300 G	200 mm
1	POR 300 90 300 G	300 mm
1	POR 450 90 300 G	450 mm
1	POR 600 90 300 G	600 mm
1	POR 750 90 300 G	750 mm
1	POR 900 90 300 G	900 mm
		Cover outside riser 90° To be fixed with 4 Cover fixing sets (ref.no. LFCC G M8)
1	PORC 200 90 300 GX	200 mm
1	PORC 300 90 300 GX	300 mm
1	PORC 450 90 300 GX	450 mm
1	PORC 600 90 300 GX	600 mm ⁽¹⁾
1	PORC 750 90 300 GX	750 mm ⁽¹⁾⁽²⁾
1	PORC 900 90 300 GX	900 mm ⁽¹⁾⁽²⁾





Packaging	Ref.no.	Fittings <i>(continued)</i>
		Equal tee To be fixed with 24 fixing sets (ref.no. LF G M10) Width
1	PT 200 300R G	200 mm
1	PT 300 300R G	300 mm
1	PT 450 300R G	450 mm
1	PT 600 300R G	600 mm
1	PT 750 300R G	750 mm
1	PT 900 300R G	900 mm
		Cover equal tee To be fixed with 7 Cover fixing sets (ref.no. LFCC G M8)
1	TCV 200 300R GX	200 mm
1	TCV 300 300R GX	300 mm
1	TCV 450 300R GX	450 mm
1	TCV 600 300R GX	600 mm ⁽¹⁾
1	TCV 750 300R GX	750 mm ⁽¹⁾⁽²⁾
1	TCV 900 300R GX	900 mm ⁽¹⁾⁽²⁾
		Branch piece To be fixed with 16 fixing sets (ref.no. LF G M10)
1	PB 200 300R G	200 mm
1	PB 300 300R G	300 mm
1	PB 450 300R G	450 mm
1	PB 600 300R G	600 mm
1	PB 750 300R G	750 mm
1	PB 900 300R G	900 mm
		Cover branch piece To be fixed with 4 Cover fixing sets (ref.no. LFCC G M8)
1	BCV 200 300R GX	200 mm
1	BCV 300 300R GX	300 mm
1	BCV 450 300R GX	450 mm
1	BCV 600 300R GX	600 mm ⁽¹⁾
1	BCV 750 300R GX	750 mm ⁽¹⁾⁽²⁾
1	BCV 900 300R GX	900 mm ⁽¹⁾⁽²⁾

(1) Interlock 600, 750 and 900 mm wide covers with 4 fixings M6 (ref.no. LFCCOV G M6) per joint for additional stability
 (2) For covers 750 and 900 mm wide, use cover stiffeners CVSTIFF for extra rigidity

Swifts cable ladder hot dip galvanised

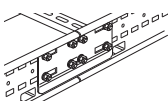
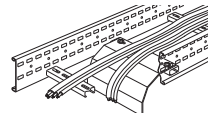
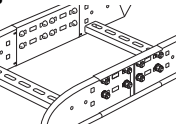
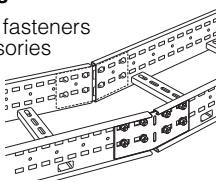
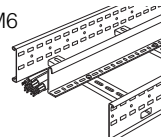
Heavy duty H = 125 mm *(continued)*

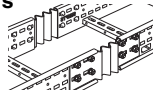
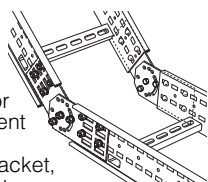
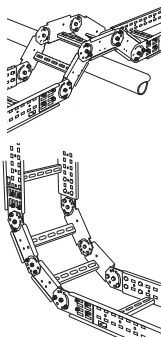
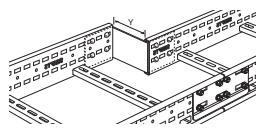
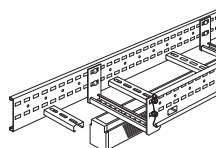
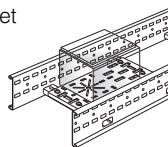
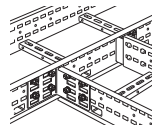





HDG
SSS
125

Packaging	Ref.no.	Accessories	Packaging	Ref.no.	Accessories <i>(continued)</i>
1	PC GZ	Straight couplers Supplied in pairs, with fasteners (8 per coupler) Use to couple straight lengths to straight lengths 	1	DO 200 GZ	Dropout plate Supplied with fasteners Use to provide local support for cables as they exit a cable ladder run between rungs Width 200 mm 
1	PFC GZ	Fitting to fitting couplers Supplied in pairs, with fasteners (8 per coupler) Use to couple fitting to fitting 	1	DO 300 GZ	300 mm
1	PH GZ	Bendable connectors Supplied in pairs with fasteners For fabricating accessories on site to make up bends, reducers and compensate for misalignment of straight lengths 	1	DO 450 GZ	450 mm
1	PDV GX	Straight divider – 3 m To be fixed with 10 fixings M6 (ref.no. LFDV G M6) 	1	DO 600 GZ	600 mm
30	LFCC G M8	Cover fixing set Including fasteners 	1	DO 750 GZ	750 mm
1	PE GZ	Flexible expansion couplers Pair supplied with fasteners 	1	DO 900 GZ	900 mm
1	PV GZ	Vertical hinged connectors Supplied in sets comprising four plates and fasteners Use with straight lengths to form risers or solve minor misalignment problems on site When used with tee bracket, vertical hinged connectors can offset tee branch 	1	PR 50 GZ	50 mm
1	PAR 200 GZ	Articulated riser Set comprises three ladder sections and the necessary vertical hinged connectors with fasteners Use to form risers or solve most misalignment problems on site Width Height 200 mm 125 mm 300 mm 125 mm 450 mm 125 mm 600 mm 125 mm 750 mm 125 mm 900 mm 125 mm 	1	PR 75 GZ	75 mm
1	PAR 300 GZ		1	PR 100 GZ	100 mm
1	PAR 450 GZ		1	PR 150 GZ	150 mm
1	PAR 600 GZ		1	PR 50 GZ	50 mm
1	PAR 750 GZ		1	PR 75 GZ	75 mm
1	PAR 900 GZ		1	PR 100 GZ	100 mm
			1	PR 150 GZ	150 mm
					Short reducer bracket Supplied singly with fasteners Use to form a reducer on site Straight reducer – use in pairs Offset reducer – use singly with straight coupler To calculate (Y) for straight reducers and offset reducers Width Height 50 mm 125 mm 75 mm 125 mm 100 mm 125 mm 150 mm 125 mm $Y = W - K$ $Y = \frac{W - K}{2}$ W = main ladder mm K = reduced ladder mm 
					Ancillary mounting bracket Supplied singly with bracket to ladder fasteners Width 200 mm 300 mm 450 mm 600 mm 750 mm 900 mm 
					Ancillary mounting plate Supplied singly with bracket to ladder fasteners For rung mounting or side rail mounting 
					Tee brackets Supplied in pairs with fasteners 
					End cap Material: plastic 

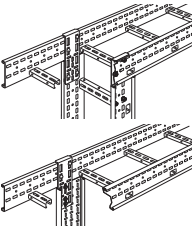
Swifts cable ladder hot dip galvanised

Heavy duty H = 125 mm *(continued)*



Packaging	Ref.no.	Accessories <i>(continued)</i>
1	M GZ	Rail-to-rail dropout brackets Supplied in pairs with fastenings Use to attach a vertical run of ladder or tray beneath a horizontal main ladder run For ladder to ladder connection or Tray to ladder connection 
10	PLFEB	Earth continuity connector Including fasteners Conductor area: 16 mm ² 
Fastenings		
50	LF G M10	Fixing set M10 x 20 
30	LFCC G M8	Cover fixing set M8 
50	LFCOV G M6	Overlap fixing set M6 
100	LFDV G M6	Divider fixing set M6 
1	CVSTIFF 750 G	Cover stiffener for covers Width 750 mm 
1	CVSTIFF 900 G	900 mm

Supports & brackets (page 58)

Swiftrack channel (page 74)

Swifts cable ladder technical information

■ Coupler sets Heavy duty (Straight couplers and fitting to fitting couplers)

Supplied in pairs, with fasteners (8 per coupler)
Fastener positioning : common to both coupler set types

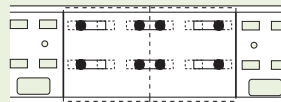

Note : when connecting straight lengths to straight lengths even when ladder is cut to length, the slots in the coupler will always align with slots in the ladder side rail.
When bolting to cut ends adjust coupler to ensure 8 bolts can be inserted

■ Fastener position

Connecting fittings with integral coupler to straight lengths

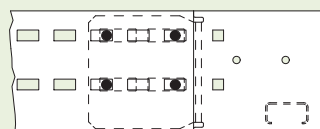

■ Closed cover installation

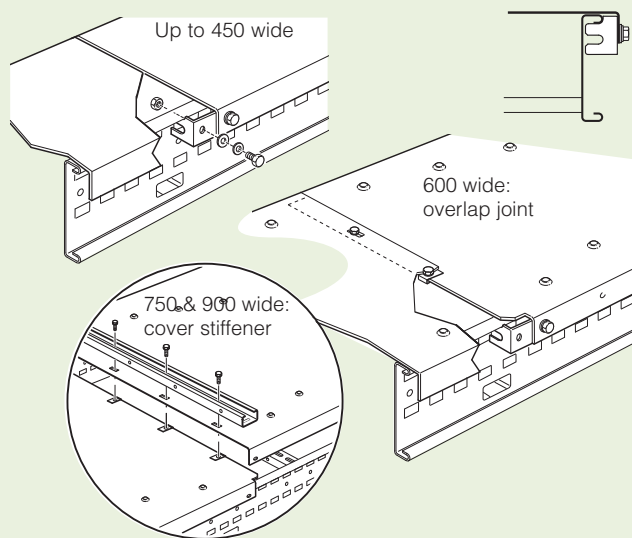

If cover does not have an overlap, or if it is cut to length, you can use a cover joint, CVF600G, CVF750G, CVF900G hot dip galv. CVF600S, CVF750S, CVF900S for stainless steel.



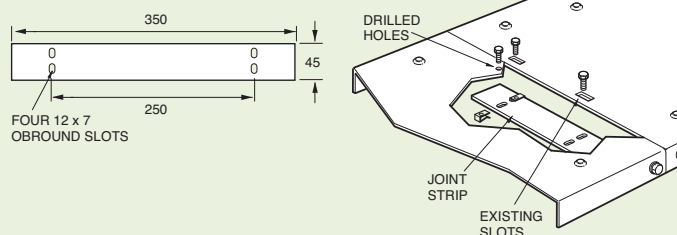







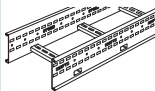
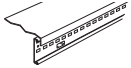
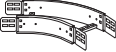

It may be necessary to drill extra holes in the cover if it has been cut to length

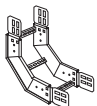

Swifts cable ladder hot dip galvanised

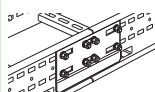
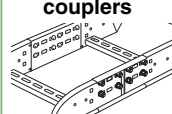
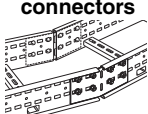
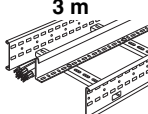
Extra heavy duty H = 150 mm

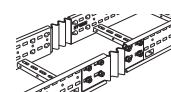
EXTRA HEAVY DUTY H = 150 mm

EXTRA HEAVY DUTY H = 150 mm	LADDER		FITTINGS					
	Width (mm)	Straight length  Length 6000 mm	Cover straight length  Length 3000 mm	Flat bend 45° 	Cover flat bend 45° 	Flat bend 90° 	Cover flat bend 90° 	Inside riser 90° 
	200	EL 200 G 6M	CV 200 GX	EFB 200 45 300 G	FBCV 200 45 300 GX	EFB 200 90 300 G	FBCV 200 90 300 GX	EIR 200 90 300 G
	300	EL 300 G 6M	CV 300 GX	EFB 300 45 300 G	FBCV 300 45 300 GX	EFB 300 90 300 G	FBCV 300 90 300 GX	EIR 300 90 300 G
	450	EL 450 G 6M	CV 450 GX	EFB 450 45 300 G	FBCV 450 45 300 GX	EFB 450 90 300 G	FBCV 450 90 300 GX	EIR 450 90 300 G
	600	EL 600 G 6M	CV 600 GX	EFB 600 45 300 G	FBCV 600 45 300 GX	EFB 600 90 300 G	FBCV 600 90 300 GX	EIR 600 90 300 G
	750	EL 750 G 6M	CV 750 GX	EFB 750 45 300 G	FBCV 750 45 300 GX	EFB 750 90 300 G	FBCV 750 90 300 GX	EIR 750 90 300 G
	900	EL 900 G 6M	CV 900 GX	EFB 900 45 300 G	FBCV 900 45 300 GX	EFB 900 90 300 G	FBCV 900 90 300 GX	EIR 900 90 300 G
	Fixing materials	2x  Ref.nr. EC GZ	4x LFCC G M8 600 - 900 mm: + 4x LFCOV G M6 750 mm: + 2x CVSTIFF 750 G 900 mm: + 2x CVSTIFF 900 G	16x  Ref.nr. LF G M10	5x LFCC G M8 600 - 900 mm: + 4x LFCOV G M6 750 mm: + 2x CVSTIFF 750 G 900 mm: + 2x CVSTIFF 900 G	16x  Ref.nr. LF G M10	5x LFCC G M8 600 - 900 mm: + 4x LFCOV G M6 750 mm: + 2x CVSTIFF 750 G 900 mm: + 2x CVSTIFF 900 G	16x  Ref.nr. LF G M10
	EXTRA HEAVY DUTY H = 150 mm							
ACCESSORIES								
Width (mm)	Straight couplers 	Fitting to fitting couplers 	Bendable connectors 	Straight divider 3 m 	Cover fixing set 	Flexible expansion couplers 	Vertical hinged connectors 	
200	EC GZ	EFC GZ	EH GZ	EDV GX	LFCC G M8	EE GZ	EV GZ	
300	EC GZ	EFC GZ	EH GZ	EDV GX	LFCC G M8	EE GZ	EV GZ	
450	EC GZ	EFC GZ	EH GZ	EDV GX	LFCC G M8	EE GZ	EV GZ	
600	EC GZ	EFC GZ	EH GZ	EDV GX	LFCC G M8	EE GZ	EV GZ	
750	EC GZ	EFC GZ	EH GZ	EDV GX	LFCC G M8	EE GZ	EV GZ	
900	EC GZ	EFC GZ	EH GZ	EDV GX	LFCC G M8	EE GZ	EV GZ	
Fixing materials	SUPPLIED IN PAIRS WITH FASTENERS	SUPPLIED IN PAIRS WITH FASTENERS	SUPPLIED IN PAIRS WITH FASTENERS	10x  Ref.nr. LFDV G M6	WITH FASTENERS	SUPPLIED IN PAIRS WITH FASTENERS	SUPPLIED IN PAIRS WITH FASTENERS	

EXTRA HEAVY DUTY H = 150 mm

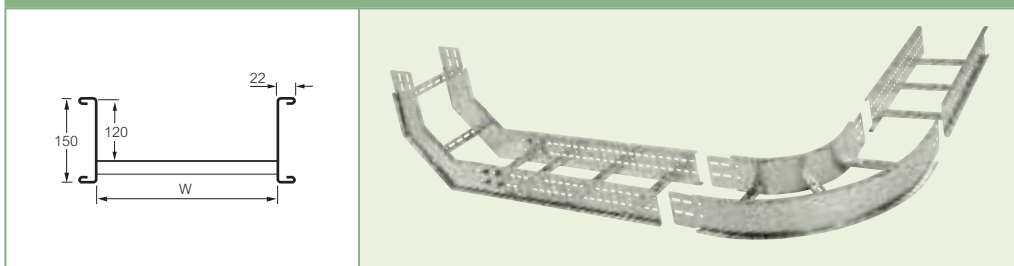

EXTRA HEAVY DUTY H = 150 mm
FITTINGS

Cover inside riser 90°	Outside riser 90°	Cover outside riser 90°	Equal tee	Cover equal tee	Branch piece	Cover branch piece
EIRC 200 90 300 GX	EOR 200 90 300 G	EORC 200 90 300 GX	ET 200 300R G	TCV 200 300R GX	EB 200 300R G	BCV 200 300R GX
EIRC 300 90 300 GX	EOR 300 90 300 G	EORC 300 90 300 GX	ET 300 300R G	TCV 300 300R GX	EB 300 300R G	BCV 300 300R GX
EIRC 450 90 300 GX	EOR 450 90 300 G	EORC 450 90 300 GX	ET 450 300R G	TCV 450 300R GX	EB 450 300R G	BCV 450 300R GX
EIRC 600 90 300 GX	EOR 600 90 300 G	EORC 600 90 300 GX	ET 600 300R G	TCV 600 300R GX	EB 600 300R G	BCV 600 300R GX
EIRC 750 90 300 GX	EOR 750 90 300 G	EORC 750 90 300 GX	ET 750 300R G	TCV 750 300R GX	EB 750 300R G	BCV 750 300R GX
EIRC 900 90 300 GX	EOR 900 90 300 G	EORC 900 90 300 GX	ET 900 300R G	TCV 900 300R GX	EB 900 300R G	BCV 900 300R GX
4x LFCC G M8 600 - 900 mm: + 4x LFCCOV G M6 750 mm: + 2x CVSTIFF 750 G 900 mm: + 2x CVSTIFF 900 G	16x Ref.nr. LF G M10	4x LFCC G M8 600 - 900 mm: + 4x LFCCOV G M6 750 mm: + 2x CVSTIFF 750 G 900 mm: + 2x CVSTIFF 900 G	24x Ref.nr. LF G M10	7x LFCC G M8 600 - 900 mm: + 4x LFCCOV G M6 750 mm: + 3x CVSTIFF 750 G 900 mm: + 3x CVSTIFF 900 G	16x Ref.nr. LF G M10	4x LFCC G M8 600 - 900 mm: + 4x LFCCOV G M6 750 mm: + 1x CVSTIFF 750 G 900 mm: + 1x CVSTIFF 900 G

EXTRA HEAVY DUTY H = 150 mm
ACCESSORIES

Articulated riser	Dropout plate	Short reducer bracket	Ancillary mounting bracket	Ancillary mounting plate	Tee brackets	End cap	Rail-to-rail dropout bracket	Earth continuity connector
EAR 200 GZ	DO 200 GZ	ER 50 GZ ⁽¹⁾ ER 75 GZ ⁽¹⁾ ER 100 GZ ⁽¹⁾ ER 150 GZ ⁽¹⁾	AMB 200 GZ	MP GZ	ETB GZ	EEC	M GZ	PLFEB
EAR 300 GZ	DO 300 GZ		AMB 300 GZ	MP GZ	ETB GZ	EEC	M GZ	PLFEB
EAR 450 GZ	DO 450 GZ		AMB 450 GZ	MP GZ	ETB GZ	EEC	M GZ	PLFEB
EAR 600 GZ	DO 600 GZ		AMB 600 GZ	MP GZ	ETB GZ	EEC	M GZ	PLFEB
EAR 750 GZ	DO 750 GZ		AMB 750 GZ	MP GZ	ETB GZ	EEC	M GZ	PLFEB
EAR 900 GZ	DO 900 GZ	AMB 900 GZ	MP GZ	ETB GZ	EEC	M GZ	PLFEB	
						-		
SUPPLIED IN SET WITH FASTENERS	WITH FASTENERS	WITH FASTENERS	SUPPLIED WITH BRACKET TO LADDER FASTENERS	SUPPLIED WITH BRACKET TO LADDER FASTENERS	SUPPLIED IN PAIRS WITH FASTENERS		SUPPLIED IN PAIRS WITH FASTENERS	WITH FASTENERS

(1) Short reducer bracket

Supplied singly with fasteners
 Use to form a reducer on site
 Straight reducer – use in pairs
 Offset reducer – use singly with straight coupler
 To calculate (Y) for straight reducers and offset reducers

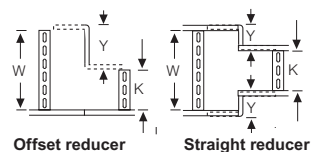
Offset reducer

$$Y = W - K$$

Straight reducer

$$Y = \frac{W - K}{2}$$

W = main ladder mm
 K = reduced ladder mm

Packaging	Ref.no.	Fastenings
50	LF G M10	Fixing set M10 x 20
30	LFCC G M8	Cover fixing set M8
50	LFCCOV G M6	Overlap fixing set M6
100	LFDV G M6	Divider fixing set M6
1	CVSTIFF 750 G	Cover stiffener for covers Width 750 mm
1	CVSTIFF 900 G	900 mm



Supports & brackets (page 58)

Swiftrack channel (page 74)

Swifts cable ladder hot dip galvanised

Extra heavy duty H = 150 mm

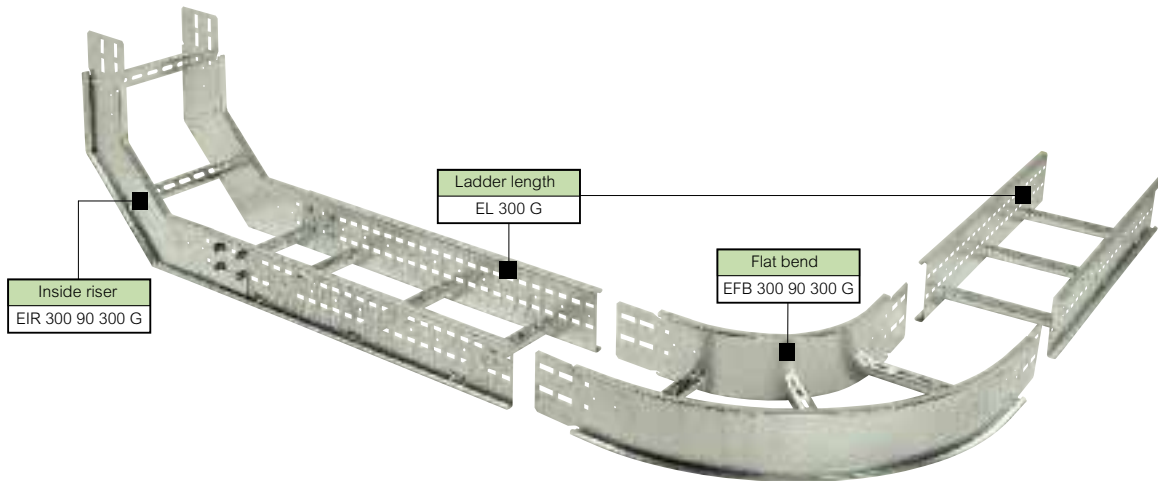

Selection chart (page 34)
Dimensions and technical information (page 52)

When connecting fittings to straight lengths, use fastener sets (see below)

Rung spacing : 300 mm between centres
Standard radius for fittings : 300 mm

Packaging	Ref.no.	Straight length	
		Width	Length
1	EL 200 G 6M	200 mm	6000 mm
1	EL 300 G 6M	300 mm	6000 mm
1	EL 450 G 6M	450 mm	6000 mm
1	EL 600 G 6M	600 mm	6000 mm
1	EL 750 G 6M	750 mm	6000 mm
1	EL 900 G 6M	900 mm	6000 mm

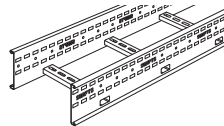

Cover straight length

To be fixed with 4 Cover fixing sets (ref.no. LFCC G M8)

Packaging	Ref.no.	Width	Length
1	CV 200 GX	200 mm	3000 mm
1	CV 300 GX	300 mm	3000 mm
1	CV 450 GX	450 mm	3000 mm
1	CV 600 GX	600 mm	3000 mm ⁽¹⁾
1	CV 750 GX	750 mm	3000 mm ⁽¹⁾⁽²⁾
1	CV 900 GX	900 mm	3000 mm ⁽¹⁾⁽²⁾

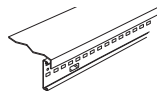

Packaging	Ref.no.	Fittings
		Flat bend 45°
		To be fixed with 16 fixing sets (ref.no. LF G M10)
		Width
1	EFB 200 45 300 G	200 mm
1	EFB 300 45 300 G	300 mm
1	EFB 450 45 300 G	450 mm
1	EFB 600 45 300 G	600 mm
1	EFB 750 45 300 G	750 mm
1	EFB 900 45 300 G	900 mm
		Cover flat bend 45°
		To be fixed with 5 Cover fixing sets (ref.no. LFCC G M8)
1	FBCV 200 45 300 GX	200 mm
1	FBCV 300 45 300 GX	300 mm
1	FBCV 450 45 300 GX	450 mm
1	FBCV 600 45 300 GX	600 mm ⁽¹⁾
1	FBCV 750 45 300 GX	750 mm ⁽¹⁾⁽²⁾
1	FBCV 900 45 300 GX	900 mm ⁽¹⁾⁽²⁾
		Flat bend 90°
		To be fixed with 16 fixing sets (ref.no. LF G M10)
1	EFB 200 90 300 G	200 mm
1	EFB 300 90 300 G	300 mm
1	EFB 450 90 300 G	450 mm
1	EFB 600 90 300 G	600 mm
1	EFB 750 90 300 G	750 mm
1	EFB 900 90 300 G	900 mm
		Cover flat bend 90°
		To be fixed with 5 Cover fixing sets (ref.no. LFCC G M8)
1	FBCV 200 90 300 GX	200 mm
1	FBCV 300 90 300 GX	300 mm
1	FBCV 450 90 300 GX	450 mm
1	FBCV 600 90 300 GX	600 mm ⁽¹⁾
1	FBCV 750 90 300 GX	750 mm ⁽¹⁾⁽²⁾
1	FBCV 900 90 300 GX	900 mm ⁽¹⁾⁽²⁾

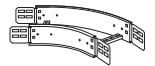

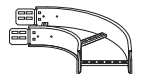



(1) Interlock 600, 750 and 900 mm wide covers with 4 fixings M6 (ref.no. LFCCOV G M6) per joint for additional stability
(2) For covers 750 and 900 mm wide, use cover stiffeners CVSTIFF for extra rigidity

Swifts cable ladder hot dip galvanised

Extra heavy duty H = 150 mm *(continued)*

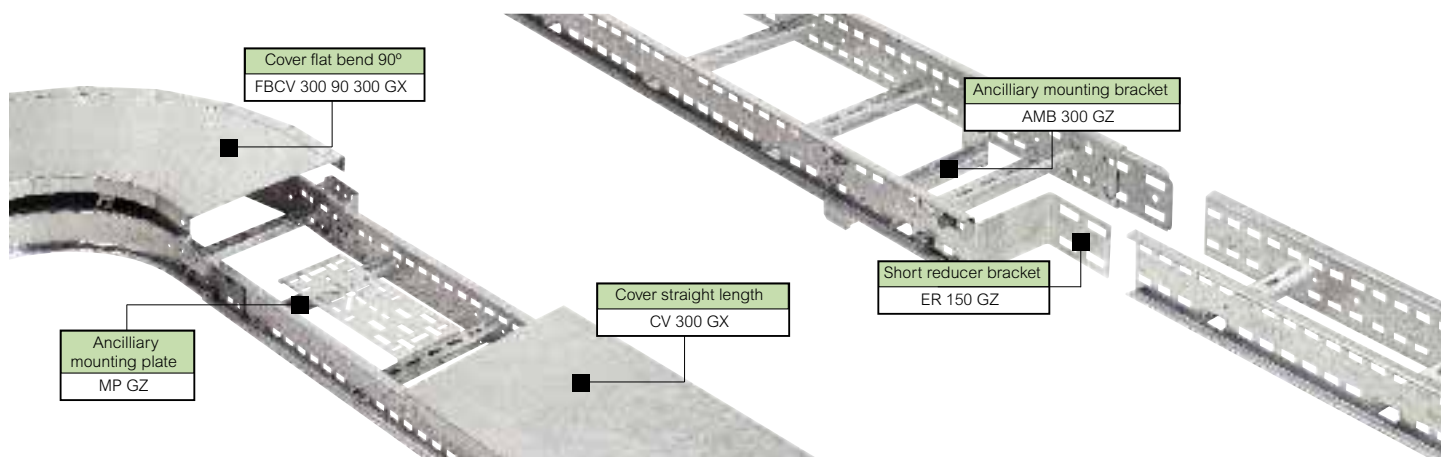
HDG
SSS
150



Packaging	Ref.no.	Fittings <i>(continued)</i>
		Inside riser 90°
		To be fixed with 16 fixing sets (ref.no. LF G M10)
		Width
1	EIR 200 90 300 G	200 mm
1	EIR 300 90 300 G	300 mm
1	EIR 450 90 300 G	450 mm
1	EIR 600 90 300 G	600 mm
1	EIR 750 90 300 G	750 mm
1	EIR 900 90 300 G	900 mm
		Cover inside riser 90°
		To be fixed with 4 Cover fixing sets (ref.no. LFCC G M8)
1	EIRC 200 90 300 GX	200 mm
1	EIRC 300 90 300 GX	300 mm
1	EIRC 450 90 300 GX	450 mm
1	EIRC 600 90 300 GX	600 mm ⁽¹⁾
1	EIRC 750 90 300 GX	750 mm ⁽¹⁾⁽²⁾
1	EIRC 900 90 300 GX	900 mm ⁽¹⁾⁽²⁾
		Outside riser 90°
		To be fixed with 16 fixing sets (ref.no. LF G M10)
1	EOR 200 90 300 G	200 mm
1	EOR 300 90 300 G	300 mm
1	EOR 450 90 300 G	450 mm
1	EOR 600 90 300 G	600 mm
1	EOR 750 90 300 G	750 mm
1	EOR 900 90 300 G	900 mm
		Cover outside riser 90°
		To be fixed with 4 Cover fixing sets (ref.no. LFCC G M8)
1	EORC 200 90 300 GX	200 mm
1	EORC 300 90 300 GX	300 mm
1	EORC 450 90 300 GX	450 mm
1	EORC 600 90 300 GX	600 mm ⁽¹⁾
1	EORC 750 90 300 GX	750 mm ⁽¹⁾⁽²⁾
1	EORC 900 90 300 GX	900 mm ⁽¹⁾⁽²⁾



Packaging	Ref.no.	Fittings <i>(continued)</i>
		Equal tee
		To be fixed with 24 fixing sets (ref.no. LF G M10)
		Width
1	ET 200 300R G	200 mm
1	ET 300 300R G	300 mm
1	ET 450 300R G	450 mm
1	ET 600 300R G	600 mm
1	ET 750 300R G	750 mm
1	ET 900 300R G	900 mm
		Cover equal tee
		To be fixed with 7 Cover fixing sets (ref.no. LFCC G M8)
1	TCV 200 300R GX	200 mm
1	TCV 300 300R GX	300 mm
1	TCV 450 300R GX	450 mm
1	TCV 600 300R GX	600 mm ⁽¹⁾
1	TCV 750 300R GX	750 mm ⁽¹⁾⁽²⁾
1	TCV 900 300R GX	900 mm ⁽¹⁾⁽²⁾
		Branch piece
		To be fixed with 16 fixing sets (ref.no. LF G M10)
1	EB 200 300R G	200 mm
1	EB 300 300R G	300 mm
1	EB 450 300R G	450 mm
1	EB 600 300R G	600 mm
1	EB 750 300R G	750 mm
1	EB 900 300R G	900 mm
		Cover branch piece
		To be fixed with 4 Cover fixing sets (ref.no. LFCC G M8)
1	BCV 200 300R GX	200 mm
1	BCV 300 300R GX	300 mm
1	BCV 450 300R GX	450 mm
1	BCV 600 300R GX	600 mm ⁽¹⁾
1	BCV 750 300R GX	750 mm ⁽¹⁾⁽²⁾
1	BCV 900 300R GX	900 mm ⁽¹⁾⁽²⁾

(1) Interlock 600, 750 and 900 mm wide covers with 4 fixings M6 (ref.no. LFCCOV G M6) per joint for additional stability
 (2) For covers 750 and 900 mm wide, use cover stiffeners CVSTIFF for extra rigidity

Swifts cable ladder hot dip galvanised

Extra heavy duty H = 150 mm *(continued)*

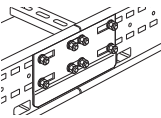
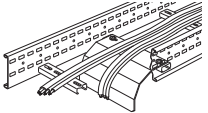
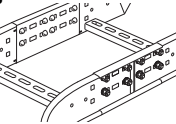
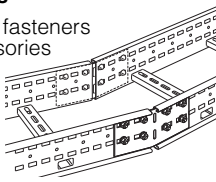
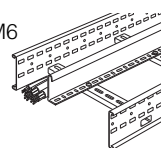

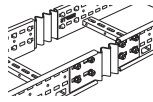
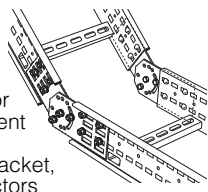
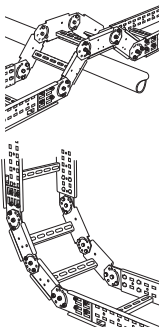





Packaging	Ref.no.	Accessories	Packaging	Ref.no.	Accessories <i>(continued)</i>
1	EC GZ	Straight couplers Supplied in pairs, with fasteners (8 per coupler) Use to couple straight lengths to straight lengths 	1	DO 200 GZ	Dropout plate Supplied with fasteners Use to provide local support for cables as they exit a cable ladder run between rungs Width 200 mm 
1	EFC GZ	Fitting to fitting couplers Supplied in pairs, with fasteners (8 per coupler) Use to couple fitting to fitting 	1	DO 300 GZ	300 mm
1	EH GZ	Bendable connectors Supplied in pairs with fasteners For fabricating accessories on site to make up bends, reducers and compensate for misalignment of straight lengths 	1	DO 450 GZ	450 mm
1	EDV GX	Straight divider – 3 m To be fixed with 10 fixings M6 (ref.no. LFDV G M6) 	1	DO 600 GZ	600 mm
30	LFCC G M8	Cover fixing set Including fasteners 	1	DO 750 GZ	750 mm
1	EE GZ	Flexible expansion couplers Pair supplied with fasteners 	1	DO 900 GZ	900 mm
1	EV GZ	Vertical hinged connectors Supplied in sets comprising four plates and fasteners Use with straight lengths to form risers or solve minor misalignment problems on site When used with tee bracket, vertical hinged connectors can offset tee branch 	1	ER 50 GZ	50 mm
1	EAR 200 GZ	Articulated riser Set comprises three ladder sections and the necessary vertical hinged connectors with fasteners Use to form risers or solve most misalignment problems on site Width Height 200 mm 150 mm 300 mm 150 mm 450 mm 150 mm 600 mm 150 mm 750 mm 150 mm 900 mm 150 mm 	1	ER 75 GZ	75 mm
1	EAR 300 GZ		1	ER 100 GZ	100 mm
1	EAR 450 GZ		1	ER 150 GZ	150 mm
1	EAR 600 GZ		1	ER 50 GZ	50 mm
1	EAR 750 GZ		1	ER 75 GZ	75 mm
1	EAR 900 GZ		1	ER 100 GZ	100 mm
			1	ER 150 GZ	150 mm
			1	ER 50 GZ	50 mm
			1	ER 75 GZ	75 mm
			1	ER 100 GZ	100 mm
			1	ER 150 GZ	150 mm
			1	ER 50 GZ	50 mm
			1	ER 75 GZ	75 mm
			1	ER 100 GZ	100 mm
			1	ER 150 GZ	150 mm
			1	ER 50 GZ	50 mm
			1	ER 75 GZ	75 mm
			1	ER 100 GZ	100 mm
			1	ER 150 GZ	150 mm
			1	ER 50 GZ	50 mm
			1	ER 75 GZ	75 mm
			1	ER 100 GZ	100 mm
			1	ER 150 GZ	150 mm
			1	ER 50 GZ	50 mm
			1	ER 75 GZ	75 mm
			1	ER 100 GZ	100 mm
			1	ER 150 GZ	150 mm
			1	ER 50 GZ	50 mm
			1	ER 75 GZ	75 mm
			1	ER 100 GZ	100 mm
			1	ER 150 GZ	150 mm
			1	ER 50 GZ	50 mm
			1	ER 75 GZ	75 mm
			1	ER 100 GZ	100 mm
			1	ER 150 GZ	150 mm
			1	ER 50 GZ	50 mm
			1	ER 75 GZ	75 mm
			1	ER 100 GZ	100 mm
			1	ER 150 GZ	150 mm
			1	ER 50 GZ	50 mm
			1	ER 75 GZ	75 mm
			1	ER 100 GZ	100 mm
			1	ER 150 GZ	150 mm
			1	ER 50 GZ	50 mm
			1	ER 75 GZ	75 mm
			1	ER 100 GZ	100 mm
			1	ER 150 GZ	150 mm
			1	ER 50 GZ	50 mm
			1	ER 75 GZ	75 mm
			1	ER 100 GZ	100 mm
			1	ER 150 GZ	150 mm
			1	ER 50 GZ	50 mm
			1	ER 75 GZ	75 mm
			1	ER 100 GZ	100 mm
			1	ER 150 GZ	150 mm
			1	ER 50 GZ	50 mm
			1	ER 75 GZ	75 mm
			1	ER 100 GZ	100 mm
			1	ER 150 GZ	150 mm
			1	ER 50 GZ	50 mm
			1	ER 75 GZ	75 mm
			1	ER 100 GZ	100 mm
			1	ER 150 GZ	150 mm
			1	ER 50 GZ	50 mm
			1	ER 75 GZ	75 mm
			1	ER 100 GZ	100 mm
			1	ER 150 GZ	150 mm
			1	ER 50 GZ	50 mm
			1	ER 75 GZ	75 mm
			1	ER 100 GZ	100 mm
			1	ER 150 GZ	150 mm
			1	ER 50 GZ	50 mm
			1	ER 75 GZ	75 mm
			1	ER 100 GZ	100 mm
			1	ER 150 GZ	150 mm
			1	ER 50 GZ	50 mm
			1	ER 75 GZ	75 mm
			1	ER 100 GZ	100 mm
			1	ER 150 GZ	150 mm
			1	ER 50 GZ	50 mm
			1	ER 75 GZ	75 mm
			1	ER 100 GZ	100 mm
			1	ER 150 GZ	150 mm
			1	ER 50 GZ	50 mm
			1	ER 75 GZ	75 mm
			1	ER 100 GZ	100 mm
			1	ER 150 GZ	150 mm
			1	ER 50 GZ	50 mm
			1	ER 75 GZ	75 mm
			1	ER 100 GZ	100 mm
			1	ER 150 GZ	150 mm
			1	ER 50 GZ	50 mm
			1	ER 75 GZ	75 mm
			1	ER 100 GZ	100 mm
			1	ER 150 GZ	150 mm
			1	ER 50 GZ	50 mm
			1	ER 75 GZ	75 mm
			1	ER 100 GZ	100 mm
			1	ER 150 GZ	150 mm
			1	ER 50 GZ	50 mm
			1	ER 75 GZ	75 mm
			1	ER 100 GZ	100 mm
			1	ER 150 GZ	150 mm
			1	ER 50 GZ	50 mm
			1	ER 75 GZ	75 mm
			1	ER 100 GZ	100 mm
			1	ER 150 GZ	150 mm
			1	ER 50 GZ	50 mm
			1	ER 75 GZ	75 mm
			1	ER 100 GZ	100 mm
			1	ER 150 GZ	150 mm
			1	ER 50 GZ	50 mm
			1	ER 75 GZ	75 mm
			1	ER 100 GZ	100 mm
			1	ER 150 GZ	150 mm
			1	ER 50 GZ	50 mm
			1	ER 75 GZ	75 mm
			1	ER 100 GZ	100 mm
			1	ER 150 GZ	150 mm
			1	ER 50 GZ	50 mm
			1	ER 75 GZ	75 mm
			1	ER 100 GZ	100 mm
			1	ER 150 GZ	150 mm
			1	ER 50 GZ	50 mm
			1	ER 75 GZ	75 mm
			1	ER 100 GZ	100 mm
			1	ER 150 GZ	150 mm
			1	ER 50 GZ	50 mm
			1	ER 75 GZ	75 mm
			1	ER 100 GZ	100 mm
			1	ER 150 GZ	150 mm
			1	ER 50 GZ	50 mm
			1	ER 75 GZ	75 mm
			1	ER 100 GZ	100 mm
			1	ER 150 GZ	150 mm
			1	ER 50 GZ	50 mm
			1	ER 75 GZ	75 mm
			1	ER 100 GZ	100 mm
			1	ER 150 GZ	150 mm
			1	ER 50 GZ	50 mm
			1	ER 75 GZ	75 mm
			1	ER 100 GZ	100 mm
			1	ER 150 GZ	150 mm
			1	ER 50 GZ	50 mm
			1	ER 75 GZ	75 mm
			1	ER 100 GZ	100 mm
			1	ER 150 GZ	150 mm
			1	ER 50 GZ	50 mm
			1	ER 75 GZ	75 mm
			1	ER 100 GZ	100 mm
			1	ER 150 GZ	150 mm
			1	ER 50 GZ	50 mm
			1	ER 75 GZ	75 mm
			1	ER 100 GZ	100 mm
			1	ER 150 GZ	150 mm
			1	ER 50 GZ	50 mm
			1	ER 75 GZ	75 mm
			1	ER 100 GZ	100 mm
			1	ER 150 GZ	150 mm
			1	ER 50 GZ	50 mm
			1	ER 75 GZ	75 mm
			1	ER 100 GZ	100 mm
			1	ER 150 GZ	150 mm
			1	ER 50 GZ	50 mm
			1	ER 75 GZ	75 mm
			1	ER 100 GZ	100 mm
			1	ER 150 GZ	150 mm
			1	ER 50 GZ	50 mm
			1	ER 75 GZ	75 mm
			1	ER 100 GZ	100 mm
			1	ER 150 GZ	150 mm
			1	ER 50 GZ	50 mm
			1	ER 75 GZ	75 mm
			1	ER 100 GZ	100 mm
			1	ER 150 GZ	150 mm
			1	ER 50 GZ	50 mm
			1	ER 75 GZ	75 mm
			1	ER 100 GZ	100 mm
			1	ER 150 GZ	150 mm
			1	ER 50 GZ	50 mm
			1	ER 75 GZ	75 mm
			1	ER 100 GZ	100 mm
			1	ER 150 GZ	150 mm
			1	ER 50 GZ	50 mm
			1	ER 75 GZ	75 mm
			1	ER 100 GZ	100 mm
			1	ER 150 GZ	150 mm
			1	ER 50 GZ	50 mm
			1	ER 75 GZ	75 mm
			1	ER 100 GZ	100 mm
			1	ER 150 GZ	150 mm
			1	ER 50 GZ	50 mm
			1	ER 75 GZ	75 mm
			1	ER 100 GZ	100 mm
			1	ER 150 GZ	150 mm
			1	ER 50 GZ	50 mm
			1	ER 75 GZ	75 mm
			1	ER 100 GZ	100 mm
			1	ER 150 GZ	150 mm
			1	ER 50 GZ	50 mm
			1	ER 75 GZ	75 mm
			1	ER 100 GZ	100 mm
			1	ER 150 GZ	150 mm
			1	ER 50 GZ	50 mm
			1	ER 75 GZ	75 mm
			1	ER 100 GZ	100 mm
			1	ER 150 GZ	150 mm
			1	ER 50 GZ	50 mm
			1	ER 75 GZ	75 mm
			1	ER 100 GZ	100 mm
			1	ER 150 GZ	150 mm
			1	ER 50 GZ	50 mm
			1	ER 75 GZ	75 mm
			1	ER 100	

Swifts cable ladder hot dip galvanised

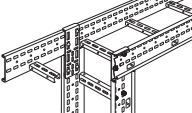
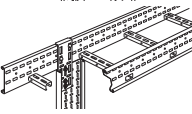
Extra heavy duty H = 150 mm *(continued)*

HDG
SSS
150

Swifts cable ladder technical information

Packaging	Ref.no.	Accessories <i>(continued)</i>
1	M GZ	<p>Rail-to-rail dropout brackets Supplied in pairs with fastenings Use to attach a vertical run of ladder or tray beneath a horizontal main ladder run For ladder to ladder connection</p>  <p>or</p> <p>Tray to ladder connection</p> 
10	PLFEB	<p>Earth continuity connector Including fasteners Conductor area: 16 mm²</p> 
50	LF G M10	<p>Fastenings Fixing set M10 x 20</p> 
30	LFCC G M8	<p>Cover fixing set M8</p> 
50	LFCOV G M6	<p>Overlap fixing set M6</p> 
100	LFDV G M6	<p>Divider fixing set M6</p> 
1	CVSTIFF 750 G	<p>Cover stiffener for covers Width 750 mm</p> 
1	CVSTIFF 900 G	<p>900 mm</p>

Supports & brackets (page 58)

Swiftrack channel (page 74)

■ Coupler sets Extra heavy duty (Straight couplers and fitting to fitting couplers)

Supplied in pairs, with fasteners (8 per coupler)
Fastener positioning : common to both coupler set types

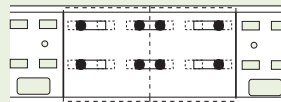

Note : when connecting straight lengths to straight lengths even when ladder is cut to length, the slots in the coupler will always align with slots in the ladder side rail.
When bolting to cut ends adjust coupler to ensure 8 bolts can be inserted

■ Fastener position

Connecting fittings with integral coupler to straight lengths

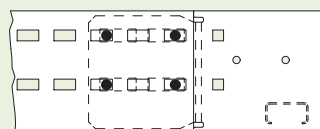

■ Bendable connectors

Supplied in pairs with fasteners

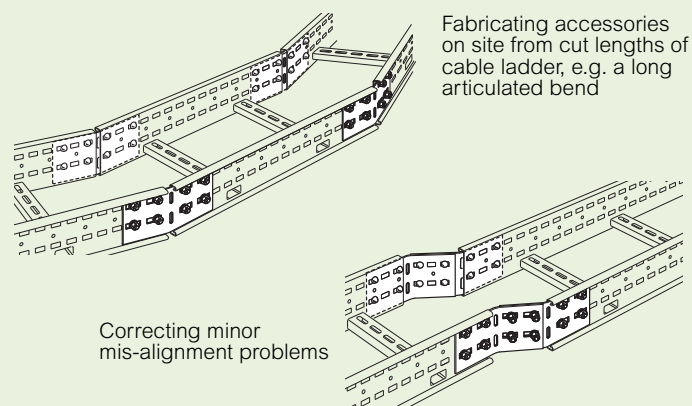

Fabricating accessories on site from cut lengths of cable ladder, e.g. a long articulated bend

Correcting minor mis-alignment problems

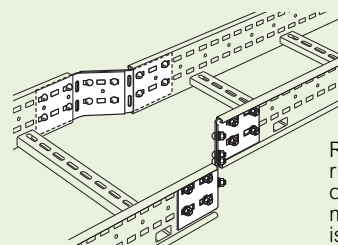







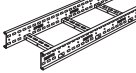
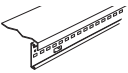
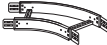

Reducing width of a run to the next size down when a properly manufactured reducer is not available





Swifts cable ladder stainless steel 316 L

Medium duty H = 100 mm

MEDIUM DUTY H = 100 mm

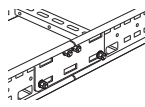
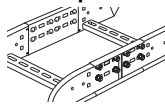
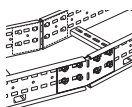
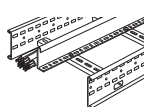
Width (mm)	LADDER		FITTINGS				
	Straight length  Length 3000 mm	Cover straight length  Length 3000 mm	Flat bend 45° 	Cover flat bend 45° 	Flat bend 90° 	Cover flat bend 90° 	Inside riser 90° 
200	ZL 200 S	CV 200 SX	ZFB 200 45 300 S	FBCV 200 45 300 SX	ZFB 200 90 300 S	FBCV 200 90 300 SX	ZIR 200 90 300 S
300	ZL 300 S	CV 300 SX	ZFB 300 45 300 S	FBCV 300 45 300 SX	ZFB 300 90 300 S	FBCV 300 90 300 SX	ZIR 300 90 300 S
450	ZL 450 S	CV 450 SX	ZFB 450 45 300 S	FBCV 450 45 300 SX	ZFB 450 90 300 S	FBCV 450 90 300 SX	ZIR 450 90 300 S
600	ZL 600 S	CV 600 SX	ZFB 600 45 300 S	FBCV 600 45 300 SX	ZFB 600 90 300 S	FBCV 600 90 300 SX	ZIR 600 90 300 S
Fixing materials	2x  Ref.nr. ZC SZ	4x LFCC S M8 600 mm: + 4x LFCOV S M6	8x  Ref.nr. LF S M10	5x LFCC S M8 600 mm: + 4x LFCOV S M6	8x  Ref.nr. LF S M10	5x LFCC S M8 600 mm: + 4x LFCOV S M6	8x  Ref.nr. LF S M10

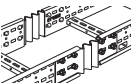
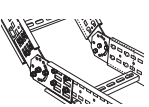
MEDIUM DUTY H = 100 mm

Width (mm)	ACCESSORIES						
	Straight couplers 	Fitting to fitting couplers 	Bendable connectors 	Straight divider 3 m 	Cover fixing set 	Flexible expansion couplers 	Vertical hinged connectors 
200	ZC SZ	ZFC SZ	ZH SZ	ZDV SX	LFCC S M8	ZE SZ	ZV SZ
300	ZC SZ	ZFC SZ	ZH SZ	ZDV SX	LFCC S M8	ZE SZ	ZV SZ
450	ZC SZ	ZFC SZ	ZH SZ	ZDV SX	LFCC S M8	ZE SZ	ZV SZ
600	ZC SZ	ZFC SZ	ZH SZ	ZDV SX	LFCC S M8	ZE SZ	ZV SZ
Fixing materials	SUPPLIED IN PAIRS WITH FASTENERS	SUPPLIED IN PAIRS WITH FASTENERS	SUPPLIED IN PAIRS WITH FASTENERS	10x  Ref.nr. LFDV S M6	WITH FASTENERS	SUPPLIED IN PAIRS WITH FASTENERS	SUPPLIED IN PAIRS WITH FASTENERS

When connecting fittings to straight lengths, use fastener sets LF S M10, see page 32

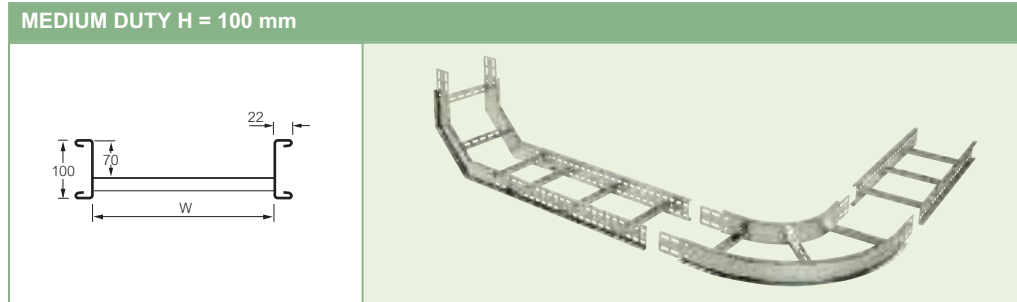

MEDIUM DUTY H = 100 mm
FITTINGS

Cover inside riser 90°	Outside riser 90°	Cover outside riser 90°	Equal tee	Cover equal tee	Branch piece	Cover branch piece
ZIRC 200 90 300 SX	ZOR 200 90 300 S	ZORC 200 90 300 SX	ZT 200 300R S	TCV 200 300R SX	ZB 200 300R S	BCV 200 300R SX
ZIRC 300 90 300 SX	ZOR 300 90 300 S	ZORC 300 90 300 SX	ZT 300 300R S	TCV 300 300R SX	ZB 300 300R S	BCV 300 300R SX
ZIRC 450 90 300 SX	ZOR 450 90 300 S	ZORC 450 90 300 SX	ZT 450 300R S	TCV 450 300R SX	ZB 450 300R S	BCV 450 300R SX
ZIRC 600 90 300 SX	ZOR 600 90 300 S	ZORC 600 90 300 SX	ZT 600 300R S	TCV 600 300R SX	ZB 600 300R S	BCV 600 300R SX
4x LFCC S M8 600 mm: + 4x LFCCOV S M6	8x Ref.nr. LF S M10	4x LFCC S M8 600 mm: + 4x LFCCOV S M6	12x Ref.nr. LF S M10	7x LFCC S M8 600 mm: + 4x LFCCOV S M6	8x Ref.nr. LF S M10	4x LFCC S M8 600 mm: + 4x LFCCOV S M6

MEDIUM DUTY H = 100 mm
ACCESSORIES

Articulated riser	Dropout plate	Short reducer bracket	Ancillary mounting plate	Tee brackets	End cap	Rail-to-rail dropout brackets	Earth continuity connector
ZAR 200 SZ	DO 200 SZ	ZR 50 SZ ⁽¹⁾	MP SZ	ZTB SZ	ZEC	M SZ	PLFEB
ZAR 300 SZ	DO 300 SZ	ZR 75 SZ ⁽¹⁾	MP SZ	ZTB SZ	ZEC	M SZ	PLFEB
ZAR 450 SZ	DO 450 SZ	ZR 100 SZ ⁽¹⁾	MP SZ	ZTB SZ	ZEC	M SZ	PLFEB
ZAR 600 SZ	DO 600 SZ	ZR 150 SZ ⁽¹⁾	MP SZ	ZTB SZ	ZEC	M SZ	PLFEB
SUPPLIED IN SET WITH FASTENERS	WITH FASTENERS	WITH FASTENERS	SUPPLIED WITH BRACKET TO LADDER FASTENERS	SUPPLIED IN PAIRS WITH FASTENERS		SUPPLIED IN PAIRS WITH FASTENERS	WITH FASTENERS

(1) Short reducer bracket

Supplied singly with fasteners
 Use to form a reducer on site
 Straight reducer – use in pairs
 Offset reducer – use singly with straight coupler
 To calculate (Y) for straight reducers and offset reducers

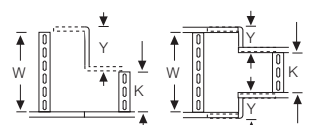

Offset reducer
 $Y = W - K$

Straight reducer
 $Y = \frac{W - K}{2}$

W = main ladder mm
 K = reduced ladder mm

Packaging	Ref.no.	Fastenings
50	LF S M10	Fixing set M10 x 20
30	LFCC S M8	Cover fixing set M8
50	LFCCOV S M6	Overlap fixing set M6
100	LFDV S M6	Divider fixing set M6



Supports & brackets (page 58)

Swiftrack channel (page 74)

Swifts cable ladder stainless steel 316 L

Medium duty H = 100 mm

SS
316 L
100

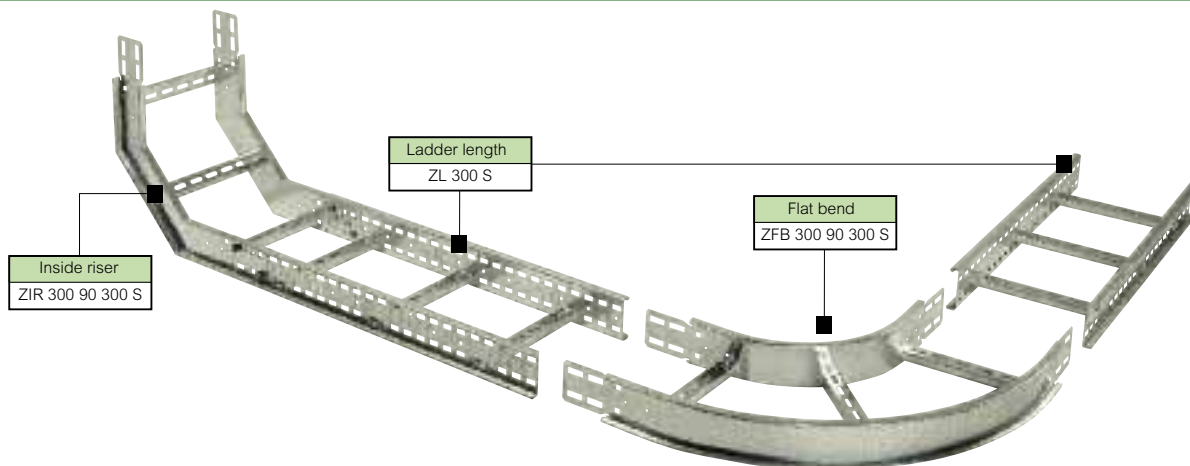

Selection chart (page 40)
Dimensions and technical information (page 52)

When connecting fittings to straight lengths, use fastener sets (see below)

Rung spacing : 300 mm between centres
Standard radius for fittings : 300 mm

Packaging	Ref.no.	Straight length	
		Width	Length
1	ZL 200 S	200 mm	3000 mm
1	ZL 300 S	300 mm	3000 mm
1	ZL 450 S	450 mm	3000 mm
1	ZL 600 S	600 mm	3000 mm

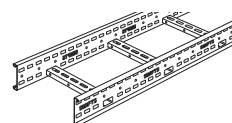

Packaging	Ref.no.	Cover straight length	
		To be fixed with 4 Cover fixing sets (ref.no. LFCC S M8)	
		Width	Length
1	CV 200 SX	200 mm	3000 mm
1	CV 300 SX	300 mm	3000 mm
1	CV 450 SX	450 mm	3000 mm
1	CV 600 SX	600 mm	3000 mm ⁽¹⁾



Packaging	Ref.no.
1	ZFB 200 45 300 S
1	ZFB 300 45 300 S
1	ZFB 450 45 300 S
1	ZFB 600 45 300 S
1	FBCV 200 45 300 SX
1	FBCV 300 45 300 SX
1	FBCV 450 45 300 SX
1	FBCV 600 45 300 SX
1	ZFB 200 90 300 S
1	ZFB 300 90 300 S
1	ZFB 450 90 300 S
1	ZFB 600 90 300 S
1	FBCV 200 90 300 SX
1	FBCV 300 90 300 SX
1	FBCV 450 90 300 SX
1	FBCV 600 90 300 SX

Fittings

Flat bend 45°

To be fixed with 8 fixing sets (ref.no. LF S M10)
Width
200 mm
300 mm
450 mm
600 mm

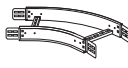

Cover flat bend 45°

To be fixed with 5 Cover fixing sets (ref.no. LFCC S M8)
200 mm
300 mm
450 mm
600 mm⁽¹⁾



Flat bend 90°

To be fixed with 8 fixing sets (ref.no. LF S M10)
200 mm
300 mm
450 mm
600 mm

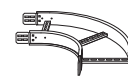

Cover flat bend 90°

To be fixed with 5 Cover fixing sets (ref.no. LFCC S M8)
200 mm
300 mm
450 mm
600 mm⁽¹⁾



(1) Interlock 600 mm wide covers with 4 fixings M6 (ref.no. LFCCOV S M6) per joint for additional stability

Swifts cable ladder stainless steel 316 L

Medium duty H = 100 mm *(continued)*

SS
316 L
100



Packaging	Ref.no.	Fittings <i>(continued)</i>
		Inside riser 90° To be fixed with 8 fixing sets (ref.no. LF S M10) Width
1	ZIR 200 90 300 S	200 mm
1	ZIR 300 90 300 S	300 mm
1	ZIR 450 90 300 S	450 mm
1	ZIR 600 90 300 S	600 mm
		Cover inside riser 90° To be fixed with 4 Cover fixing sets (ref.no. LFCC S M8)
1	ZIRC 200 90 300 SX	200 mm
1	ZIRC 300 90 300 SX	300 mm
1	ZIRC 450 90 300 SX	450 mm
1	ZIRC 600 90 300 SX	600 mm ⁽¹⁾
		Outside riser 90° To be fixed with 8 fixing sets (ref.no. LF S M10)
1	ZOR 200 90 300 S	200 mm
1	ZOR 300 90 300 S	300 mm
1	ZOR 450 90 300 S	450 mm
1	ZOR 600 90 300 S	600 mm
		Cover outside riser 90° To be fixed with 4 Cover fixing sets (ref.no. LFCC S M8)
1	ZORC 200 90 300 SX	200 mm
1	ZORC 300 90 300 SX	300 mm
1	ZORC 450 90 300 SX	450 mm
1	ZORC 600 90 300 SX	600 mm ⁽¹⁾





Packaging	Ref.no.	Fittings <i>(continued)</i>
		Equal tee To be fixed with 12 fixing sets (ref.no. LF S M10) Width
1	ZT 200 300R S	200 mm
1	ZT 300 300R S	300 mm
1	ZT 450 300R S	450 mm
1	ZT 600 300R S	600 mm
		Cover equal tee To be fixed with 7 Cover fixing sets (ref.no. LFCC S M8)
1	TCV 200 300R SX	200 mm
1	TCV 300 300R SX	300 mm
1	TCV 450 300R SX	450 mm
1	TCV 600 300R SX	600 mm ⁽¹⁾
		Branch piece To be fixed with 8 fixing sets (ref.no. LF S M10)
1	ZB 200 300R S	200 mm
1	ZB 300 300R S	300 mm
1	ZB 450 300R S	450 mm
1	ZB 600 300R S	600 mm
		Cover branch piece To be fixed with 4 Cover fixing sets (ref.no. LFCC S M8)
1	BCV 200 300R SX	200 mm
1	BCV 300 300R SX	300 mm
1	BCV 450 300R SX	450 mm
1	BCV 600 300R SX	600 mm ⁽¹⁾

(1) Interlock 600 mm wide covers with 4 fixings M6 (ref.no. LFCCOV S M6) per joint for additional stability

Swifts cable ladder stainless steel 316 L

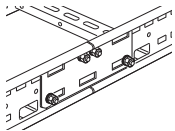
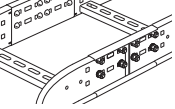
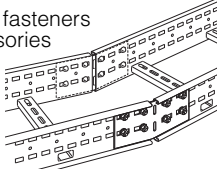
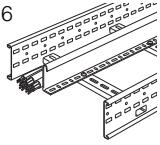
Medium duty H = 100 mm

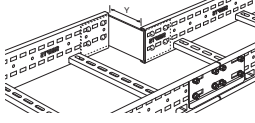
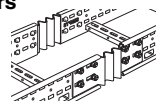
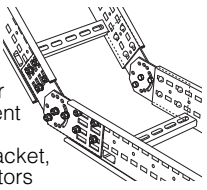
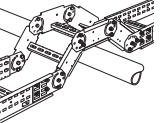
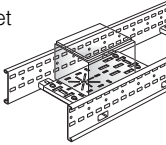
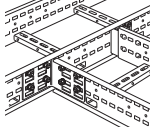
SS
316 L
100







Packaging	Ref.no.	Accessories	Packaging	Ref.no.	Accessories (continued)
1	ZC SZ	Straight couplers Supplied in pairs, with fasteners (4 per coupler) Use to couple straight lengths to straight lengths 	1	DO 200 SZ	Dropout plate Supplied with fasteners Use to provide local support for cables as they exit a cable ladder run between rungs Width 200 mm
1	ZFC SZ	Fitting to fitting couplers Supplied in pairs, with fasteners (4 per coupler) Use to couple fitting to fitting 	1	DO 300 SZ	300 mm
1	ZH SZ	Bendable connectors Supplied in pairs with fasteners For fabricating accessories on site to make up bends, reducers and compensate for misalignment of straight lengths 	1	DO 450 SZ	450 mm
1	ZDV SX	Straight divider – 3 m To be fixed with 10 fixings M6 (ref.no. LFDV S M6) 	1	DO 600 SZ	600 mm
30	LFCC S M8	Cover fixing set Including fasteners 	1	ZR 50 SZ	Short reducer bracket Supplied singly with fasteners Use to form a reducer on site Straight reducer – use in pairs Offset reducer – use singly with straight coupler To calculate (Y) for straight reducers and offset reducers 
1	ZE SZ	Flexible expansion couplers Pair supplied with fasteners 	1	ZR 75 SZ	Width Height 50 mm 100 mm
1	ZV SZ	Vertical hinged connectors Supplied in sets comprising four plates and fasteners Use with straight lengths to form risers or solve minor misalignment problems on site When used with tee bracket, vertical hinged connectors can offset tee branch 	1	ZR 100 SZ	75 mm 100 mm
1	ZAR 200 SZ	Articulated riser Set comprises three ladder sections and the necessary vertical hinged connectors with fasteners Use to form risers or solve most misalignment problems on site 	1	ZR 150 SZ	100 mm 100 mm
1	ZAR 300 SZ	Width Height 200 mm 100 mm	1	MP SZ	Ancillary mounting plate Supplied singly with bracket to ladder fasteners For rung mounting or side rail mounting 
1	ZAR 450 SZ	300 mm 100 mm	1	ZTB SZ	Tee brackets Supplied in pairs with fasteners 
1	ZAR 600 SZ	450 mm 100 mm	10	ZEC	End cap Material: plastic 
		600 mm 100 mm			

Swifts cable ladder

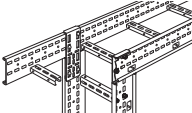
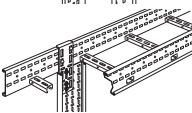
stainless steel 316 L

Medium duty H = 100 mm

SS
316 L
100

Packaging	Ref.no.	Accessories <i>(continued)</i>
1	M SZ	<p>Rail-to-rail dropout brackets Supplied in pairs with fastenings Use to attach a vertical run of ladder or tray beneath a horizontal main ladder run For ladder to ladder connection</p>  <p>or</p> <p>Tray to ladder connection</p> 
10	PLFEB	<p>Earth continuity connector Including fasteners Conductor area: 16 mm²</p> 
50	LF S M10	<p>Fastenings Fixing set M10 x 20</p> 
30	LFCC S M8	<p>Cover fixing set M8</p> 
50	LFCOV S M6	<p>Overlap fixing set M6</p> 
100	LFDV S M6	<p>Divider fixing set M6</p> 

Supports & brackets (page 58)

Swiftrack channel (page 74)

Swifts cable ladder

technical information

■ Coupler sets Medium duty (Straight couplers and fitting to fitting couplers)

Supplied in pairs, with fasteners (4 per coupler)
Fastener positioning : common to both coupler set types



Note : when connecting straight lengths to straight lengths even when ladder is cut to length, the slots in the coupler will always align with slots in the ladder side rail.
When bolting to cut ends adjust coupler to ensure 4 bolts can be inserted

■ Fastener position

Connecting fittings with integral coupler to straight lengths

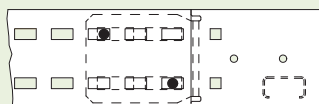

■ Covers for H = 100 mm, H = 125 mm and H = 150 mm ladder

Medium duty H = 100 mm, Heavy duty H = 125 mm and Extra heavy duty H = 150 mm use the same covers and cover clips (except inside and outside risers).

Cover clips are adjustable for closed or ventilated covers (ventilated riser covers available on request).

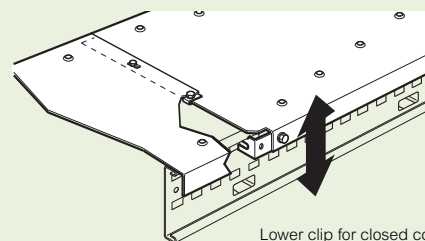

Lower clip for closed covers
Raise clip for ventilated covers

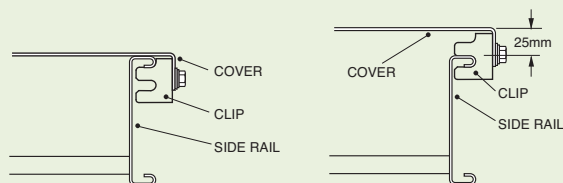

■ Flexible expansion couplers



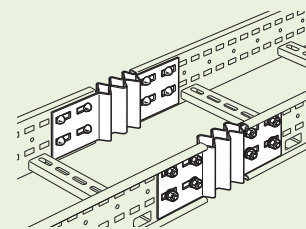



Supplied in pairs with fasteners
Provide a semi-flexible joint to compensate for relative movement when spanning separate structures or changes in ladder lengths due to temperature variation.
Mounting pairs of couplers back-to-back, will increase the stiffness of each joint



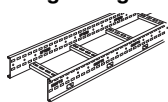
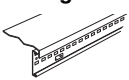
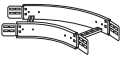

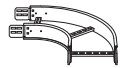





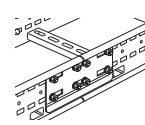
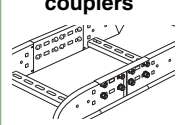
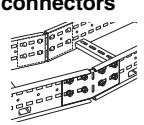
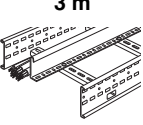

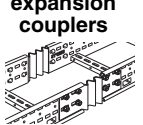
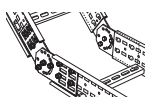
Swifts cable ladder stainless steel 316 L

Heavy duty H = 125 mm

HEAVY DUTY H = 125 mm

Width (mm)	LADDER		FITTINGS			
	Straight length	Cover straight length	Flat bend 45°	Cover flat bend 45°	Flat bend 90°	Cover flat bend 90°
	 Length 3000 mm	 Length 3000 mm				
200	PL 200 S	CV 200 SX	PFB 200 45 300 S	FBCV 200 45 300 SX	PFB 200 90 300 S	FBCV 200 90 300 SX
300	PL 300 S	CV 300 SX	PFB 300 45 300 S	FBCV 300 45 300 SX	PFB 300 90 300 S	FBCV 300 90 300 SX
450	PL 450 S	CV 450 SX	PFB 450 45 300 S	FBCV 450 45 300 SX	PFB 450 90 300 S	FBCV 450 90 300 SX
600	PL 600 S	CV 600 SX	PFB 600 45 300 S	FBCV 600 45 300 SX	PFB 600 90 300 S	FBCV 600 90 300 SX
750	PL 750 S	CV 750 SX	PFB 750 45 300 S	FBCV 750 45 300 SX	PFB 750 90 300 S	FBCV 750 90 300 SX
900	PL 900 S	CV 900 SX	PFB 900 45 300 S	FBCV 900 45 300 SX	PFB 900 90 300 S	FBCV 900 90 300 SX
Fixing materials	2x  Ref.nr. PC SZ	4x LFCC S M8 600 - 900 mm: + 4x LFCCOV S M6 750 mm: + 2x CVSTIFF 750 S 900 mm: + 2x CVSTIFF 900 S	16x  Ref.nr. LF S M10	5x LFCC S M8 600 - 900 mm: + 4x LFCCOV S M6 750 mm: + 2x CVSTIFF 750 S 900 mm: + 2x CVSTIFF 900 S	16x  Ref.nr. LF S M10	5x LFCC S M8 600 - 900 mm: + 4x LFCCOV S M6 750 mm: + 2x CVSTIFF 750 S 900 mm: + 2x CVSTIFF 900 S

Width (mm)	ACCESSORIES						
	Straight couplers	Fitting to fitting couplers	Bendable connectors	Straight divider 3 m	Cover fixing set	Flexible expansion couplers	Vertical hinged connectors
							
200	PC SZ	PFC SZ	PH SZ	PDV SX	LFCC S M8	PE SZ	PV SZ
300	PC SZ	PFC SZ	PH SZ	PDV SX	LFCC S M8	PE SZ	PV SZ
450	PC SZ	PFC SZ	PH SZ	PDV SX	LFCC S M8	PE SZ	PV SZ
600	PC SZ	PFC SZ	PH SZ	PDV SX	LFCC S M8	PE SZ	PV SZ
750	PC SZ	PFC SZ	PH SZ	PDV SX	LFCC S M8	PE SZ	PV SZ
900	PC SZ	PFC SZ	PH SZ	PDV SX	LFCC S M8	PE SZ	PV SZ
Fixing materials	 SUPPLIED IN PAIRS WITH FASTENERS	 SUPPLIED IN PAIRS WITH FASTENERS	 SUPPLIED IN PAIRS WITH FASTENERS	10x  Ref.nr. LFDV S M6	 WITH FASTENERS	 SUPPLIED IN PAIRS WITH FASTENERS	 SUPPLIED IN PAIRS WITH FASTENERS

When connecting fittings to straight lengths, use fastener sets LF S M10, see page 35

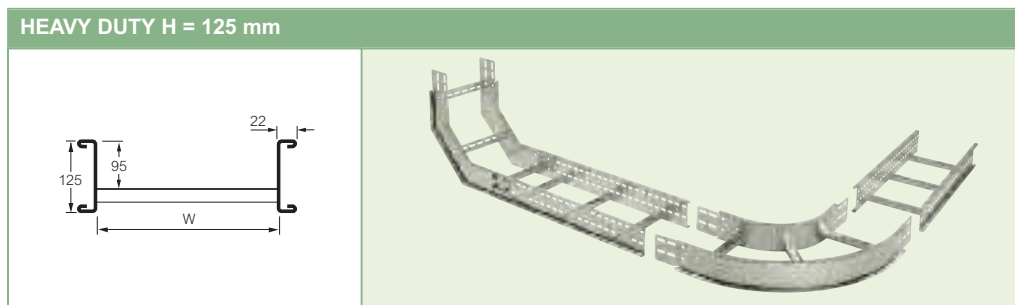

HEAVY DUTY H = 125 mm
FITTINGS

Inside riser 90°	Cover inside riser 90°	Outside riser 90°	Cover outside riser 90°	Equal tee	Cover equal tee	Branch piece	Cover branch piece
PIR 200 90 300 S	PIRC 200 90 300 SX	POR 200 90 300 S	PORC 200 90 300 SX	PT 200 300R S	TCV 200 300R SX	PB 200 300R S	BCV 200 300R SX
PIR 300 90 300 S	PIRC 300 90 300 SX	POR 300 90 300 S	PORC 300 90 300 SX	PT 300 300R S	TCV 300 300R SX	PB 300 300R S	BCV 300 300R SX
PIR 450 90 300 S	PIRC 450 90 300 SX	POR 450 90 300 S	PORC 450 90 300 SX	PT 450 300R S	TCV 450 300R SX	PB 450 300R S	BCV 450 300R SX
PIR 600 90 300 S	PIRC 600 90 300 SX	POR 600 90 300 S	PORC 600 90 300 SX	PT 600 300R S	TCV 600 300R SX	PB 600 300R S	BCV 600 300R SX
PIR 750 90 300 S	PIRC 750 90 300 SX	POR 750 90 300 S	PORC 750 90 300 SX	PT 750 300R S	TCV 750 300R SX	PB 750 300R S	BCV 750 300R SX
PIR 900 90 300 S	PIRC 900 90 300 SX	POR 900 90 300 S	PORC 900 90 300 SX	PT 900 300R S	TCV 900 300R SX	PB 900 300R S	BCV 900 300R SX
16x Ref.nr. LF S M10	4x LFCC S M8 600 - 900 mm: + 4x LFCOV S M6 750 mm: + 2x CVSTIFF 750 S 900 mm: + 2x CVSTIFF 900 S	16x Ref.nr. LF S M10	4x LFCC S M8 600 - 900 mm: + 4x LFCOV S M6 750 mm: + 2x CVSTIFF 750 S 900 mm: + 2x CVSTIFF 900 S	24x Ref.nr. LF S M10	7x LFCC S M8 600 - 900 mm: + 4x LFCOV S M6 750 mm: + 3x CVSTIFF 750 S 900 mm: + 3x CVSTIFF 900 S	16x Ref.nr. LF S M10	4x LFCC S M8 600 - 900 mm: + 4x LFCOV S M6 750 mm: + 1x CVSTIFF 750 S 900 mm: + 1x CVSTIFF 900 S

HEAVY DUTY H = 125 mm
ACCESSORIES

Articulated riser	Dropout plate	Short reducer bracket	Ancillary mounting plate	Tee brackets	End cap	Rail-to-rail dropout bracket	Earth continuity connector
PAR 200 SZ	DO 200 SZ	PR 50 SZ PR 75 SZ PR 100 SZ PR 150 SZ	MP SZ	PTB SZ	PEC	M SZ	PLFEB
PAR 300 SZ	DO 300 SZ		MP SZ	PTB SZ	PEC	M SZ	PLFEB
PAR 450 SZ	DO 450 SZ		MP SZ	PTB SZ	PEC	M SZ	PLFEB
PAR 600 SZ	DO 600 SZ		MP SZ	PTB SZ	PEC	M SZ	PLFEB
PAR 750 SZ	DO 750 SZ		MP SZ	PTB SZ	PEC	M SZ	PLFEB
PAR 900 SZ	DO 900 SZ		MP SZ	PTB SZ	PEC	M SZ	PLFEB
SUPPLIED IN SET WITH FASTENERS	WITH FASTENERS	WITH FASTENERS	SUPPLIED WITH BRACKET TO LADDER FASTENERS	SUPPLIED IN PAIRS WITH FASTENERS		SUPPLIED IN PAIRS WITH FASTENERS	WITH FASTENERS

(1) Short reducer bracket

Supplied singly with fasteners
 Use to form a reducer on site
 Straight reducer – use in pairs
 Offset reducer – use singly with straight coupler
 To calculate (Y) for straight reducers and offset reducers

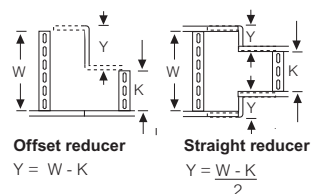

Packaging	Ref.no.	Fastenings
50	LF S M10	Fixing set M10 x 20
30	LFCC S M8	Cover fixing set M8
50	LFCOV S M6	Overlap fixing set M6
100	LFDV S M6	Divider fixing set M6
1	CVSTIFF 750 S	Cover stiffener for covers Width 750 mm
1	CVSTIFF 900 S	900 mm

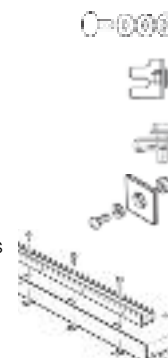

Supports & brackets (page 58)

Swiftrack channel (page 74)

Swifts cable ladder stainless steel 316 L

Heavy duty H = 125 mm

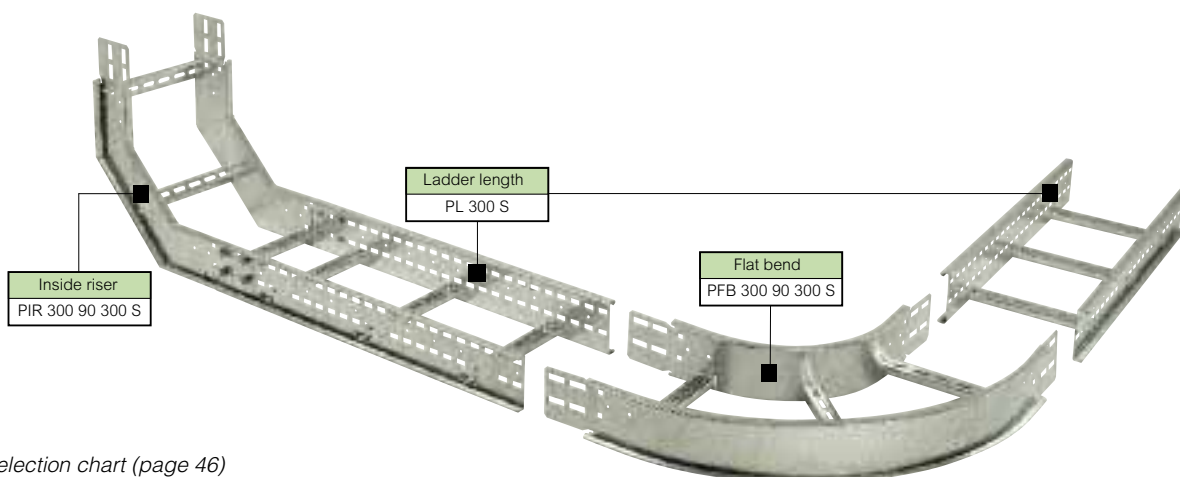
SS
316 L
125



Selection chart (page 46)
Dimensions and technical information (page 52)

When connecting fittings to straight lengths, use fastener sets (see below)

Rung spacing : 300 mm between centres

Standard radius for fittings : 300 mm

Packaging	Ref.no.	Straight length	
		Width	Length
1	PL 200 S	200 mm	3000 mm
1	PL 300 S	300 mm	3000 mm
1	PL 450 S	450 mm	3000 mm
1	PL 600 S	600 mm	3000 mm
1	PL 750 S	750 mm	3000 mm
1	PL 900 S	900 mm	3000 mm

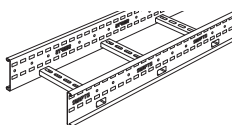



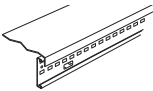

Packaging	Ref.no.	Cover straight length	
		Width	Length
1	CV 200 SX	200 mm	3000 mm
1	CV 300 SX	300 mm	3000 mm
1	CV 450 SX	450 mm	3000 mm
1	CV 600 SX	600 mm	3000 mm ⁽¹⁾
1	CV 750 SX	750 mm	3000 mm ⁽¹⁾⁽²⁾
1	CV 900 SX	900 mm	3000 mm ⁽¹⁾⁽²⁾

To be fixed with 4 Cover fixing sets (ref.no. LFCC S M8)

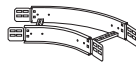

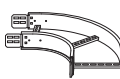
Packaging	Ref.no.	Fittings
		Flat bend 45°
		To be fixed with 16 fixing sets (ref.no. LF S M10)
		Width
1	PFB 200 45 300 S	200 mm
1	PFB 300 45 300 S	300 mm
1	PFB 450 45 300 S	450 mm
1	PFB 600 45 300 S	600 mm
1	PFB 750 45 300 S	750 mm
1	PFB 900 45 300 S	900 mm
		Cover flat bend 45°
		To be fixed with 5 Cover fixing sets (ref.no. LFCC S M8)
1	FBCV 200 45 300 SX	200 mm
1	FBCV 300 45 300 SX	300 mm
1	FBCV 450 45 300 SX	450 mm
1	FBCV 600 45 300 SX	600 mm ⁽¹⁾
1	FBCV 750 45 300 SX	750 mm ⁽¹⁾⁽²⁾
1	FBCV 900 45 300 SX	900 mm ⁽¹⁾⁽²⁾
		Flat bend 90°
		To be fixed with 16 fixing sets (ref.no. LF S M10)
1	PFB 200 90 300 S	200 mm
1	PFB 300 90 300 S	300 mm
1	PFB 450 90 300 S	450 mm
1	PFB 600 90 300 S	600 mm
1	PFB 750 90 300 S	750 mm
1	PFB 900 90 300 S	900 mm
		Cover flat bend 90°
		To be fixed with 5 Cover fixing sets (ref.no. LFCC S M8)
1	FBCV 200 90 300 SX	200 mm
1	FBCV 300 90 300 SX	300 mm
1	FBCV 450 90 300 SX	450 mm
1	FBCV 600 90 300 SX	600 mm ⁽¹⁾
1	FBCV 750 90 300 SX	750 mm ⁽¹⁾⁽²⁾
1	FBCV 900 90 300 SX	900 mm ⁽¹⁾⁽²⁾







(1) Interlock 600, 750 and 900 mm wide covers with 4 fixings M6 (ref.no. LFCCOV S M6) per joint for additional stability
(2) For covers 750 and 900 mm wide, use cover stiffeners CVSTIFF for extra rigidity

Swifts cable ladder stainless steel 316 L

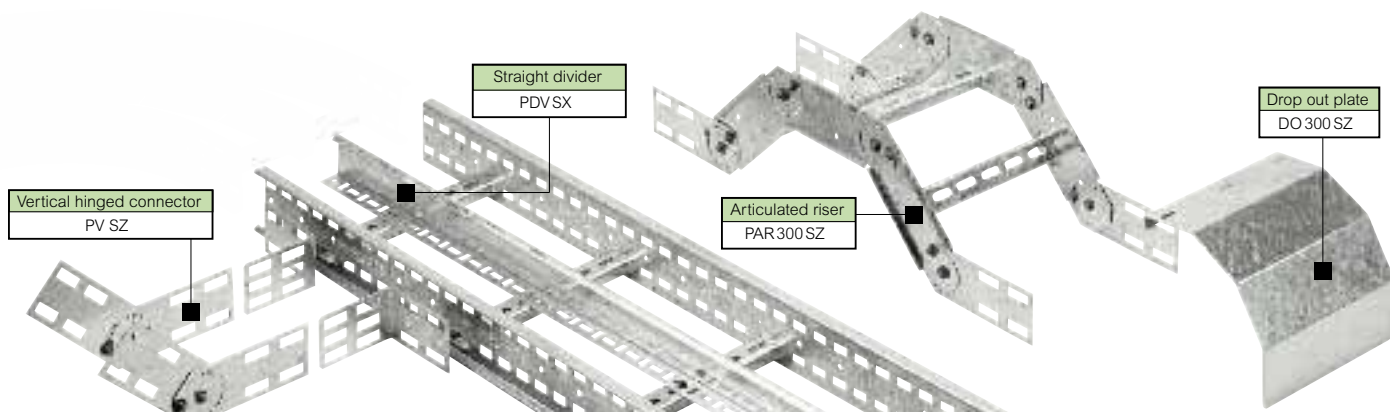
Heavy duty H = 125 mm *(continued)*





SS
316 L
125

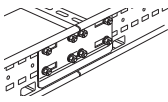
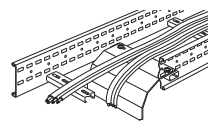
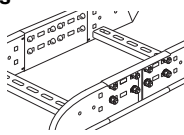
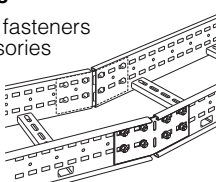
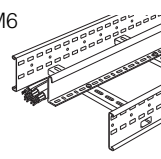

Packaging	Ref.no.	Fittings <i>(continued)</i>
		Inside riser 90° To be fixed with 16 fixing sets (ref.no. LF S M10) Width
1	PIR 200 90 300 S	200 mm
1	PIR 300 90 300 S	300 mm
1	PIR 450 90 300 S	450 mm
1	PIR 600 90 300 S	600 mm
1	PIR 750 90 300 S	750 mm
1	PIR 900 90 300 S	900 mm
		Cover inside riser 90° To be fixed with 4 Cover fixing sets (ref.no. LFCC S M8)
1	PIRC 200 90 300 SX	200 mm
1	PIRC 300 90 300 SX	300 mm
1	PIRC 450 90 300 SX	450 mm
1	PIRC 600 90 300 SX	600 mm ⁽¹⁾
1	PIRC 750 90 300 SX	750 mm ⁽¹⁾⁽²⁾
1	PIRC 900 90 300 SX	900 mm ⁽¹⁾⁽²⁾
		Outside riser 90° To be fixed with 16 fixing sets (ref.no. LF S M10)
1	POR 200 90 300 S	200 mm
1	POR 300 90 300 S	300 mm
1	POR 450 90 300 S	450 mm
1	POR 600 90 300 S	600 mm
1	POR 750 90 300 S	750 mm
1	POR 900 90 300 S	900 mm
		Cover outside riser 90° To be fixed with 4 Cover fixing sets (ref.no. LFCC S M8)
1	PORC 200 90 300 SX	200 mm
1	PORC 300 90 300 SX	300 mm
1	PORC 450 90 300 SX	450 mm
1	PORC 600 90 300 SX	600 mm ⁽¹⁾
1	PORC 750 90 300 SX	750 mm ⁽¹⁾⁽²⁾
1	PORC 900 90 300 SX	900 mm ⁽¹⁾⁽²⁾

Packaging	Ref.no.	Fittings <i>(continued)</i>
		Equal tee To be fixed with 24 fixing sets (ref.no. LF S M10) Width
1	PT 200 300R S	200 mm
1	PT 300 300R S	300 mm
1	PT 450 300R S	450 mm
1	PT 600 300R S	600 mm
1	PT 750 300R S	750 mm
1	PT 900 300R S	900 mm
		Cover equal tee To be fixed with 7 Cover fixing sets (ref.no. LFCC S M8)
1	TCV 200 300R SX	200 mm
1	TCV 300 300R SX	300 mm
1	TCV 450 300R SX	450 mm
1	TCV 600 300R SX	600 mm ⁽¹⁾
1	TCV 750 300R SX	750 mm ⁽¹⁾⁽²⁾
1	TCV 900 300R SX	900 mm ⁽¹⁾⁽²⁾
		Branch piece To be fixed with 16 fixing sets (ref.no. LF S M10)
1	PB 200 300R S	200 mm
1	PB 300 300R S	300 mm
1	PB 450 300R S	450 mm
1	PB 600 300R S	600 mm
1	PB 750 300R S	750 mm
1	PB 900 300R S	900 mm
		Cover branch piece To be fixed with 4 Cover fixing sets (ref.no. LFCC S M8)
1	BCV 200 300R SX	200 mm
1	BCV 300 300R SX	300 mm
1	BCV 450 300R SX	450 mm
1	BCV 600 300R SX	600 mm ⁽¹⁾
1	BCV 750 300R SX	750 mm ⁽¹⁾⁽²⁾
1	BCV 900 300R SX	900 mm ⁽¹⁾⁽²⁾

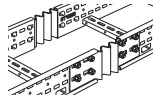
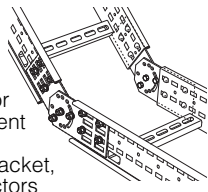
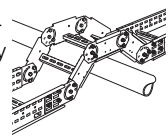
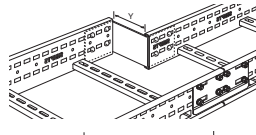
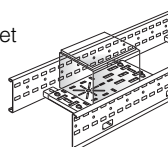
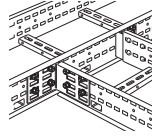
(1) Interlock 600, 750 and 900 mm wide covers with 4 fixings M6 (ref.no. LFCCOV S M6) per joint for additional stability
 (2) For covers 750 and 900 mm wide, use cover stiffeners CVSTIFF for extra rigidity

Packaging	Ref.no.	Accessories	Packaging	Ref.no.	Accessories <i>(continued)</i>
1	PC SZ	Straight couplers Supplied in pairs, with fasteners (8 per coupler) Use to couple straight lengths to straight lengths 	1	DO 200 SZ	Dropout plate Supplied with fasteners Use to provide local support for cables as they exit a cable ladder run between rungs Width 200 mm 
1	PFC SZ	Fitting to fitting couplers Supplied in pairs, with fasteners (8 per coupler) Use to couple fitting to fitting 	1	DO 300 SZ	300 mm
1	PH SZ	Bendable connectors Supplied in pairs with fasteners For fabricating accessories on site to make up bends, reducers and compensate for misalignment of straight lengths 	1	DO 450 SZ	450 mm
1	PDV SX	Straight divider – 3 m To be fixed with 10 fixings M6 (ref.no. LFDV S M6) 	1	DO 600 SZ	600 mm
30	LFCC S M8	Cover fixing set Including fasteners 	1	DO 750 SZ	750 mm
1	PE SZ	Flexible expansion couplers Pair supplied with fasteners 	1	DO 900 SZ	900 mm
1	PV SZ	Vertical hinged connectors Supplied in sets comprising four plates and fasteners Use with straight lengths to form risers or solve minor misalignment problems on site When used with tee bracket, vertical hinged connectors can offset tee branch 	1	PR 50 SZ	50 mm
1	PAR 200 SZ	Articulated riser Set comprises three ladder sections and the necessary vertical hinged connectors with fasteners Use to form risers or solve most misalignment problems on site 	1	PR 75 SZ	75 mm
1	PAR 300 SZ	Width Height	1	PR 100 SZ	100 mm 125 mm
1	PAR 450 SZ	200 mm 125 mm	1	PR 150 SZ	150 mm 125 mm
1	PAR 600 SZ	300 mm 125 mm			
1	PAR 750 SZ	450 mm 125 mm			
1	PAR 900 SZ	600 mm 125 mm			
		750 mm 125 mm			
		900 mm 125 mm			
					Short reducer bracket Supplied singly with fasteners Use to form a reducer on site Straight reducer – use in pairs Offset reducer – use singly with straight coupler To calculate (Y) for straight reducers and offset reducers Width Height 50 mm 125 mm 75 mm 125 mm 100 mm 125 mm 150 mm 125 mm  Offset reducer: $Y = W - K$ Straight reducer: $Y = \frac{W - K}{2}$ W = main ladder mm K = reduced ladder mm
					Ancillary mounting plate Supplied singly with bracket to ladder fasteners For rung mounting or side rail mounting 
					Tee brackets Supplied in pairs with fasteners 
					End cap Material: plastic 

Swifts cable ladder stainless steel 316 L

heavy duty H = 125 mm *(continued)*

SS
316 L
125

Packaging Ref.no. **Accessories** *(continued)*

1 M SZ
Rail-to-rail dropout brackets
Supplied in pairs with fastenings
Use to attach a vertical run of ladder or tray beneath a horizontal main ladder run
For ladder to ladder connection
or
Tray to ladder connection

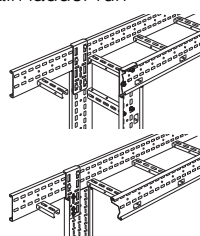

10 PLFEB
Earth continuity connector
Including fasteners
Conductor area: 16 mm²

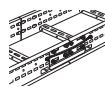

50 LF S M10 Fixing set M10 x 20
30 LFCC S M8 Cover fixing set M8
50 LFCOV S M6 Overlap fixing set M6
100 LFDV S M6 Divider fixing set M6
Cover stiffener for covers
Width
1 CVSTIFF 750 S 750 mm
1 CVSTIFF 900 S 900 mm



Supports & brackets (page 58)

Swiftrack channel (page 74)

Swifts cable ladder technical information

■ Coupler sets Heavy duty (Straight couplers and fitting to fitting couplers)

Supplied in pairs, with fasteners (8 per coupler)
Fastener positioning : common to both coupler set types

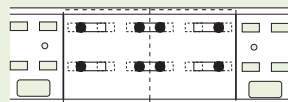

Note : when connecting straight lengths to straight lengths even when ladder is cut to length, the slots in the coupler will always align with slots in the ladder side rail.
When bolting to cut ends adjust coupler to ensure 8 bolts can be inserted

■ Fastener position

Connecting fittings with integral coupler to straight lengths

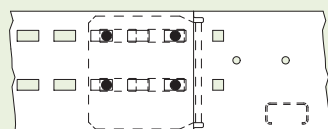

■ Fasteners for fittings

Fasteners for fittings are purchased separately – see table below for requirements

	Number of fasteners required per fitting type	
	Medium duty	Heavy and Extra heavy duty
Flat Bends	8	16
Outside/ Inside riser	8	16
Tees	12	24
Branch piece	8	16

■ Vertical hinged connectors

Supplied in sets comprising four plates and fasteners
Use with straight lengths to form risers or solve minor misalignment problems on site

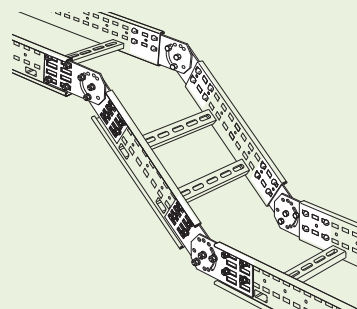

Connect together to form pre-set angles or pre-assemble for adjustment on site using the holes / slots given below

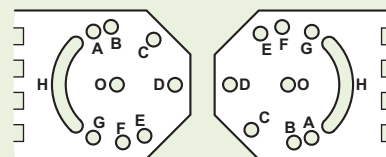

Type	15°	18°	22.5°	30°	45°
ZV / PV / EV	G:C	A:F	E:B	B:G	F:C

Swifts cable ladder

technical information

■ Rung details light duty

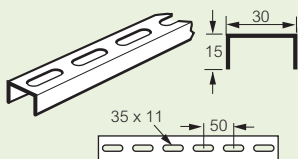

■ Rung details medium / heavy / extra heavy duty

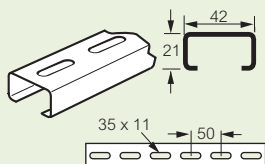

■ Coupler sets (Straight couplers and fitting to fitting couplers)

Light duty coupling (cut lengths only)

Cut the side rail at the joggle joint 100 mm longer than the required length. Locate the joggle end of a straight length or accessory in the side rail of the cut length and butt join the opposite side rails. Secure the joggle joint. Fit a coupler to the outside of the butt joined side rails across the joint. Adjust the coupler position to align the slots with the side rail slots and secure it with the fastenings.

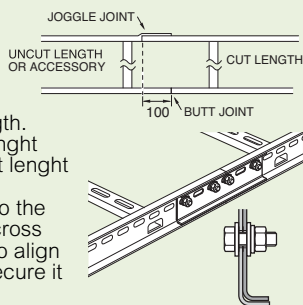

Note: because of integrated coupler the effective length of a light duty cable ladder is 2900 mm

Medium duty H = 100 mm

Supplied in pairs, with fasteners (4 per coupler)

Fastener positioning : common to both coupler set types



Note : when connecting straight lengths to straight lengths even when ladder is cut to length, the slots in the coupler will always align with slots in the ladder side rail. When bolting to cut ends adjust coupler to ensure 4 bolts can be inserted

Heavy duty H = 125 mm and Extra heavy duty H = 150 mm

Supplied in pairs, with fasteners (8 per coupler)

Fastener positioning : common to both coupler set types

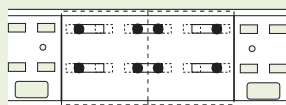

Note : when connecting straight lengths to straight lengths even when ladder is cut to length, the slots in the coupler will always align with slots in the ladder side rail. When bolting to cut ends adjust coupler to ensure 8 bolts can be inserted

■ Own weight of cable ladder (in N/m)

Height (mm)	Width					
	200	300	450	600	750	900
50	18	19	24	-	-	-
100	43	46	51	56	-	-
125	62	66	71	75	88	94
150	71	74	78	84	96	103

■ Fasteners for fittings

Fasteners for fittings are purchased separately – see table below for requirements

	Number of fasteners required per fitting type	
	Medium duty	Heavy and Extra heavy duty
Flat Bends	8	16
Outside/ Inside riser	8	16
Tees	12	24
Branch piece	8	16

Fastener sets LF G M10 and LF S M10 comprising: M10 coach bolt, flat washer, spring washer and nut

■ Fastener position

Connecting fittings with integral coupler to straight lengths

Medium duty H = 100 mm

Heavy duty H = 125 mm and Extra heavy duty H = 150 mm

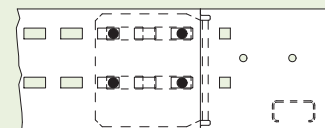
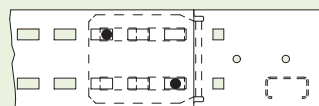

■ Flat bends

X = length of fitting from each 'end' of centre-line (not including integral coupler)

Y = length from each 'end' of the fitting to the point at which the centre-lines intersect (not including integral coupler)

C = length of the centre-line from each 'end' of the fitting to the point at which the centre-lines intersect (not including integral coupler)

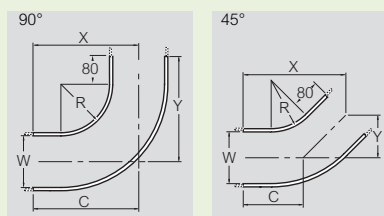

All dimensions (mm)

Width (W)	Radius (R)	90°			45°		
		X	Y	C	X	Y	C
200	300	478	478	478	418	173	245
300	300	528	528	528	453	188	266
450	300	603	603	603	506	210	297
600	300	678	678	678	559	232	328
750	300	753	753	753	612	254	359
900	300	828	828	828	665	276	390

■ Risers

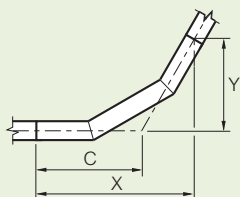

X = length of fitting from each 'end' of centre-line
 Y = length from each 'end' of the fitting to the point at which the centre-lines intersect
 C = length of the centre-line from each 'end' of the fitting to the point at which the centre-lines intersect
 Dimensions shown are identical for both inside and outside risers

Medium duty H = 100 mm

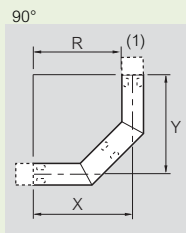

Width (W)	Radius (R)	X	90° Y	C
All	300	350	350	350

Heavy duty H = 125 mm

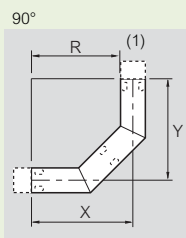

Width (W)	Radius (R)	X	90° Y	C
All	300	363	363	363

Extra heavy duty H = 150 mm

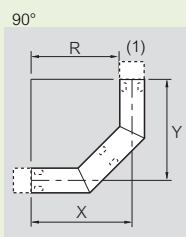

Width (W)	Radius (R)	X	90° Y	C
All	300	375	375	375

■ Straight dividers

Fasteners to be ordered separately (LFDV)

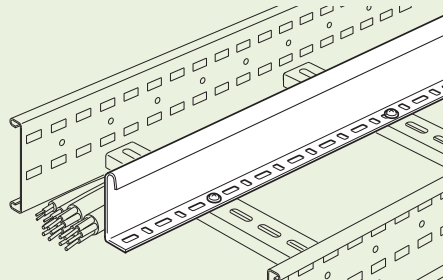

■ Closed cover installation

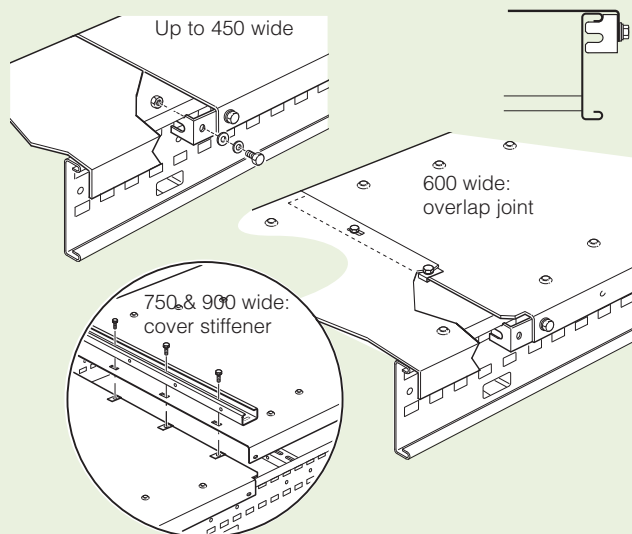

If cover does not have an overlap, or if it is cut to length, you can use a cover joint, CVF600G, CVF750G, CVF900G hot dip galv. CVF600S, CVF750S, CVF900S for stainless steel.

It may be necessary to drill extra holes in the cover if it has been cut to length

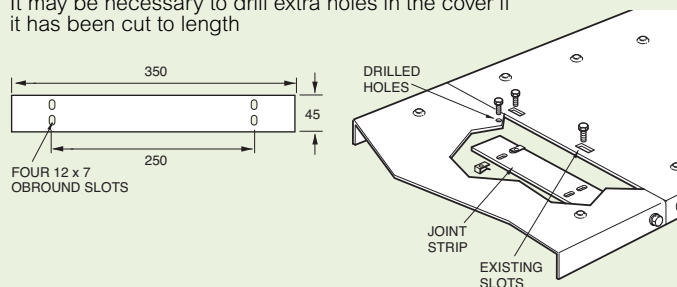

■ Covers for H = 100 mm, H = 125 mm and H = 150 mm ladder

Medium duty H = 100 mm, Heavy duty H = 125 mm and Extra heavy duty H = 150 mm use the same covers and cover clips (except inside and outside risers).

Cover clips are adjustable for closed or ventilated covers (ventilated riser covers available on request).

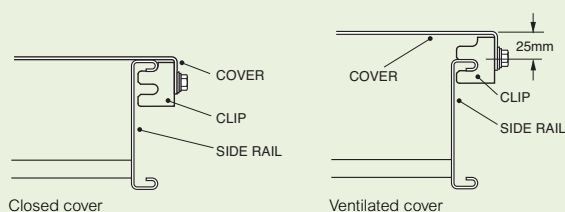
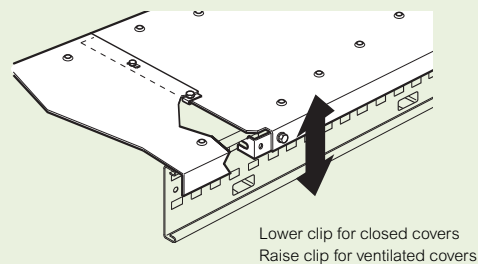

Swifts cable ladder

technical information

■ Bendable connectors

Supplied in pairs with fasteners

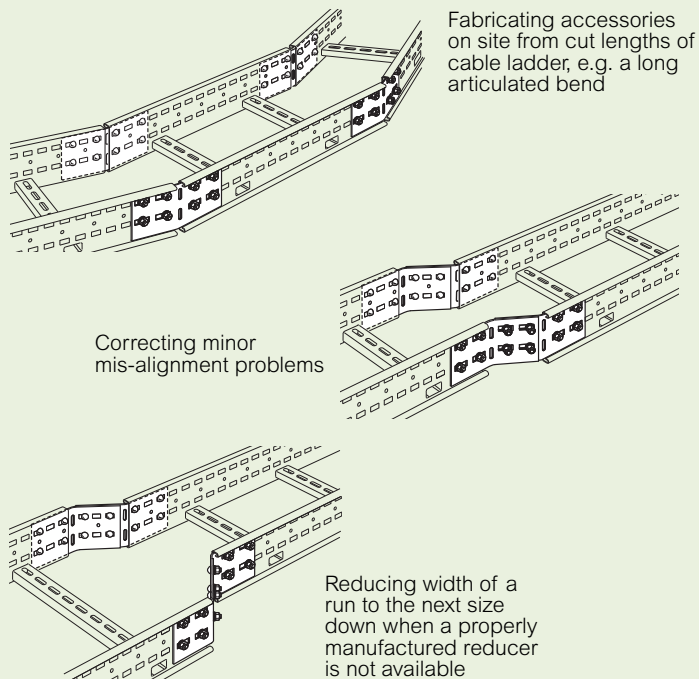

■ Flexible expansion couplers

Supplied in pairs with fasteners
Provide a semi-flexible joint to compensate for relative movement when spanning separate structures or changes in ladder lengths due to temperature variation.
Mounting pairs of couplers back-to-back, will increase the stiffness of each joint

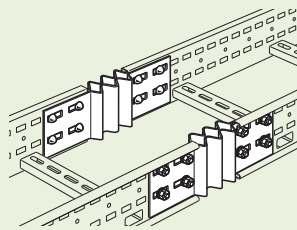

■ Short reducer brackets

Supplied singly with fasteners
Use to form a reducer on site
Straight reducer
– use in pairs
Offset reducer
– use singly with straight coupler

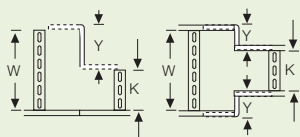

Use the following calculations to establish ladder width reduction
This measurement (Y), can then be inserted into relevant ref.no.'s to show bracket size required

Offset reducer	Straight reducer
$Y = W - K$	$Y = \frac{W - K}{2}$

W = main ladder mm
K = reduced ladder mm

Short reducer brackets can also be used to convert an equal tee into an unequal tee

■ Vertical hinged connectors

Supplied in sets comprising four plates and fasteners
Use with straight lengths to form risers or solve minor misalignment problems on site

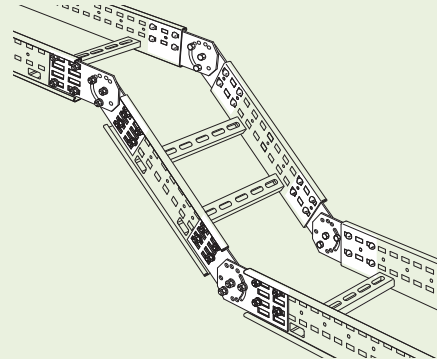

Connect together to form pre-set angles or pre-assemble for adjustment on site using the holes / slots given below

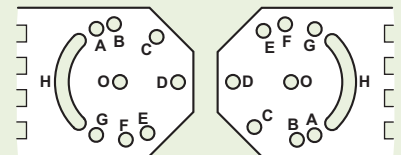

Type	15°	18°	22.5°	30°	45°
ZV / PV / EV	G:C	A:F	E:B	B:G	F:C

■ Rail-to-rail dropout brackets

Supplied in pairs with fasteners
Use to attach a vertical run of ladder or tray beneath a horizontal main ladder run

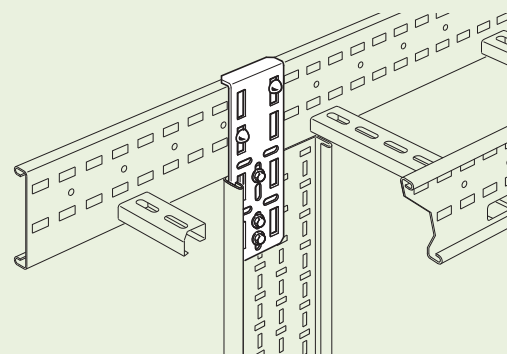
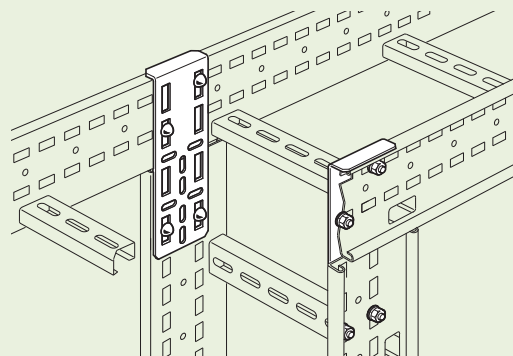

Articulated risers

Set comprises three ladder sections and the necessary vertical hinged connectors with fasteners
Use to form risers or solve most misalignment problems on site

Sections required for a given angle

R = radius

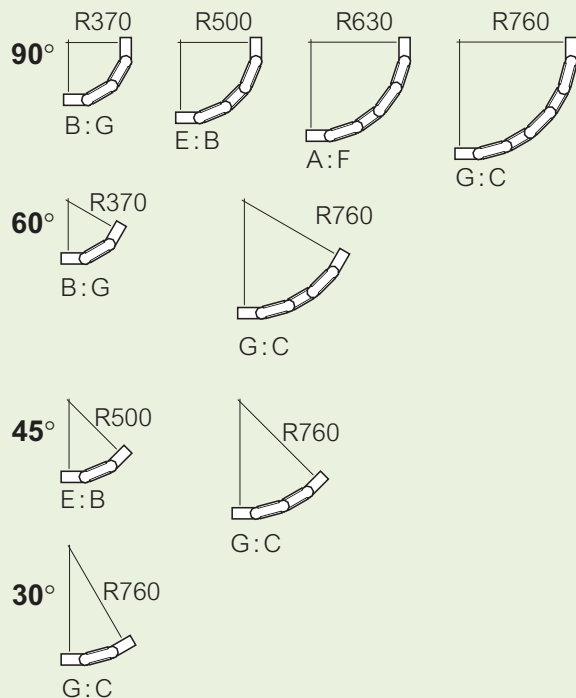

Connect together to form pre-set angles or pre-assembled for adjustment on site using the holes / slots shown

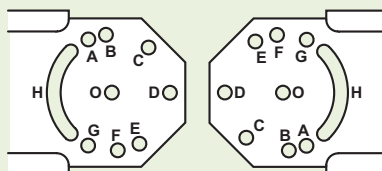

Type	15°	18°	22.5°	30°	45°
ZAR / PAR / EAR	G : C	A : F	E : B	B : G	F : C

Dropout plate

Supplied with fasteners
Use to provide local support for cables as they exit a cable ladder run between rungs

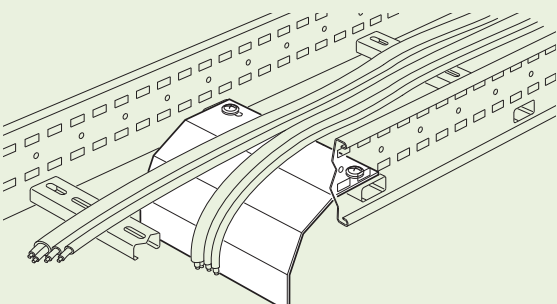

Tee brackets

Supplied in pairs with fasteners
Use to create a straight or 90° branch off a straight ladder run

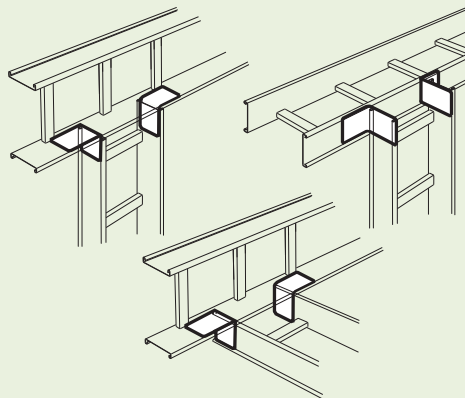

Couple with vertical hinged connectors or bendable connectors to offset the branch

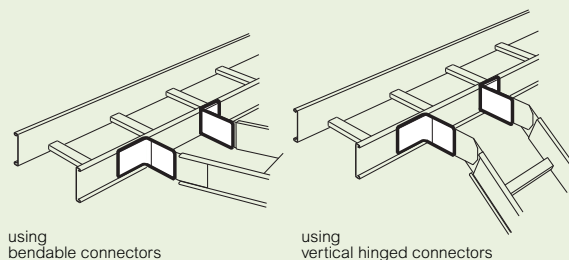

Main ladder run	Permitted ladder branch		
	Medium duty	Heavy duty	Extra heavy duty
Medium duty H = 100 mm	ZTB	-	-
Heavy duty H = 125 mm	ZTB	PTB	-
Extra heavy duty H = 150 mm	ZTB	PTB	ETB

Earth continuity connector

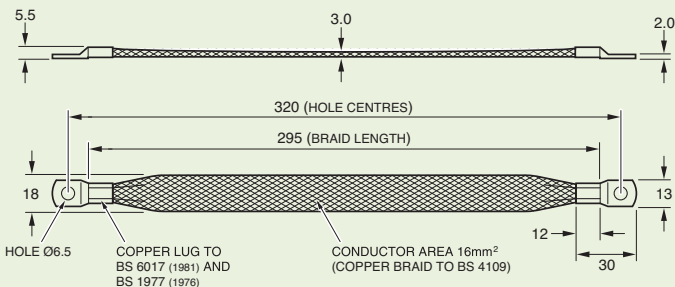

All dimensions given are in millimetres (mm).

Swifts cable ladder

technical information

■ Ancillary mounting bracket

Supplied singly with bracket to ladder fastener
Slots for M6 fasteners are provided for mounting ancillary items

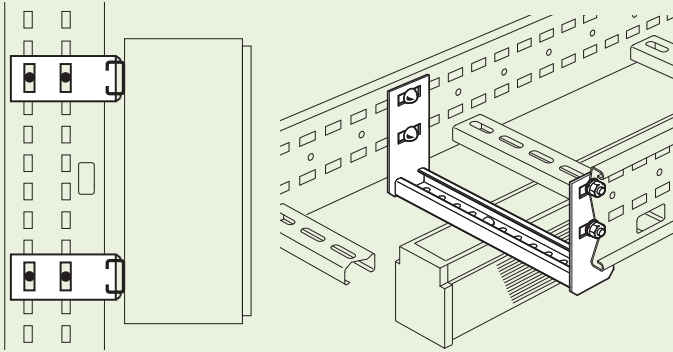

■ Ancillary mounting plate

Supplied singly with plate to ladder fasteners
Use to mount small lightweight items of ancillary equipment to cable ladder runs

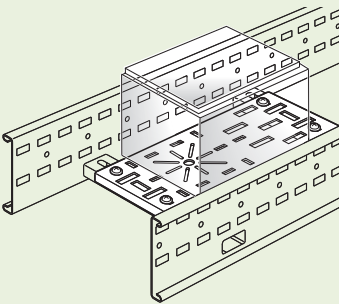

RUNG MOUNTING
(Plan view)

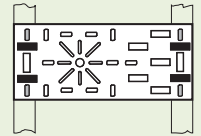

■ with type 1 rung
□ with type 2 rung

Medium duty H = 100 mm

SIDE RAIL MOUNTING
(Side view)

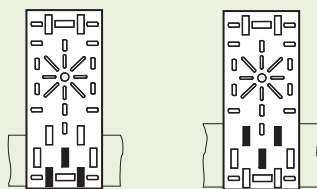

Medium duty
H = 100 mm

Heavy duty
H = 125 mm
Extra heavy duty
H = 150 mm

Swifts cable ladder

branch piece

■ Branch piece

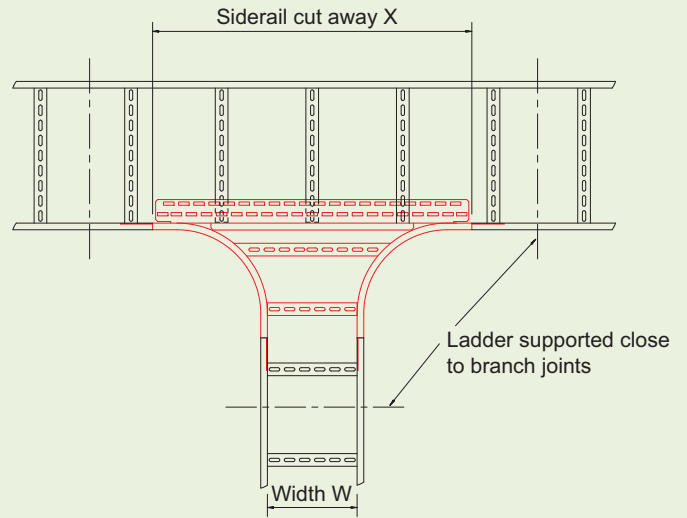

NOMINAL WIDTH W	SIDERAIL CUT AWAY X
200	958
300	1058
450	1208
600	1358
750	1508
900	1658

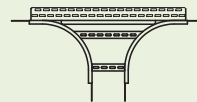

200 wide

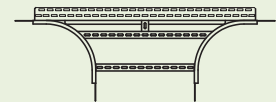

600 wide

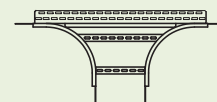

300 wide



750 wide

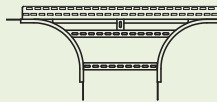

450 wide

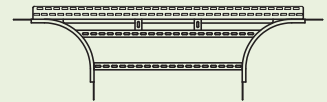

900 wide



CABLOFIL

Heavy duty steel wire cable tray

WORLD STANDARD IN STEEL WIRE CABLE TRAY

- > Safe-T-Edge: patented T-weld that prevents damage to the cables.
- > Easy to clean: no collection of bacteria or dust because of the open structure.
- > Heavy duty wire cable tray: the first heavy duty tray in the world. Allows higher loads and longer spans, thus reducing the number of supports.
- > Quick screwless fixings (FAS), a complete time-saving system.
- > Special trays like C-tray or G-Mini offer perfect alternatives for cable tubes.
- > Easycutter: work quickly and safely, a special shaped cutter that does not damage the zinc coating.
- > Standard finishes: electro zinc plated, hot dip galvanised, stainless steel 316L

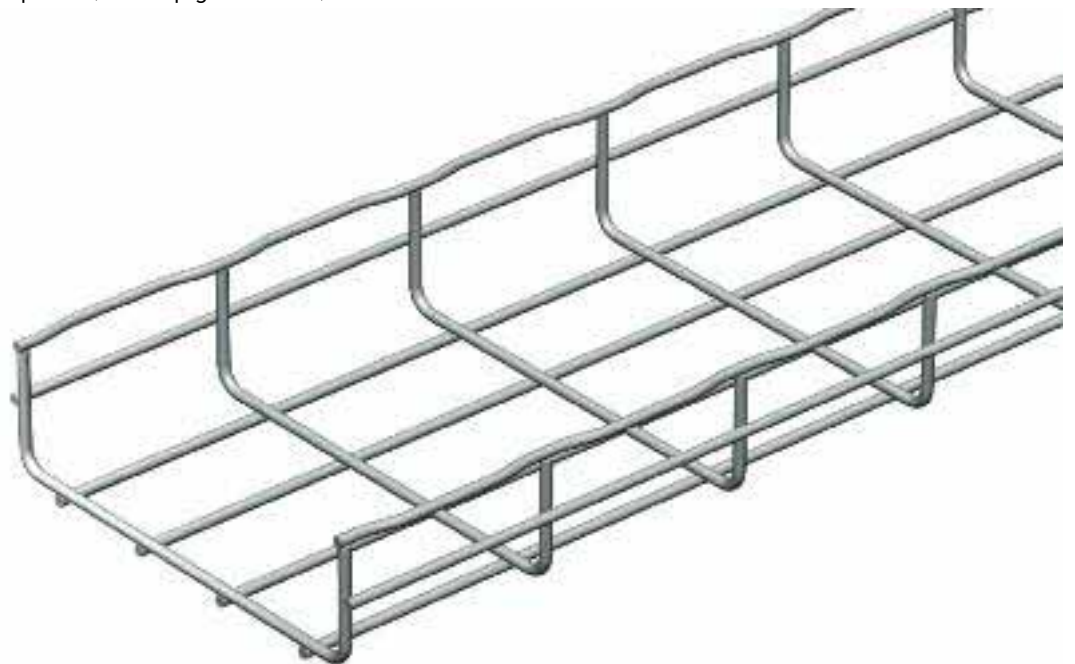

Cablofil steel wire tray CF 54



CABLOFIL STEEL WIRE CABLE TRAY

World standard in steel wire tray.
 Cablofil is the most tested and certified steel wire cable tray system.
 Cablofil meets the highest demands and offers the best mechanical characteristics and fastest installation.
 The patented Safe-T-Edge™ technology protects both cable and installer.

A suitable solution for any situation

Legrand has a broad range of supporting systems for cable ladders. There is a choice of various solutions (wall, ceiling and 2 finishes for dedicated performance).

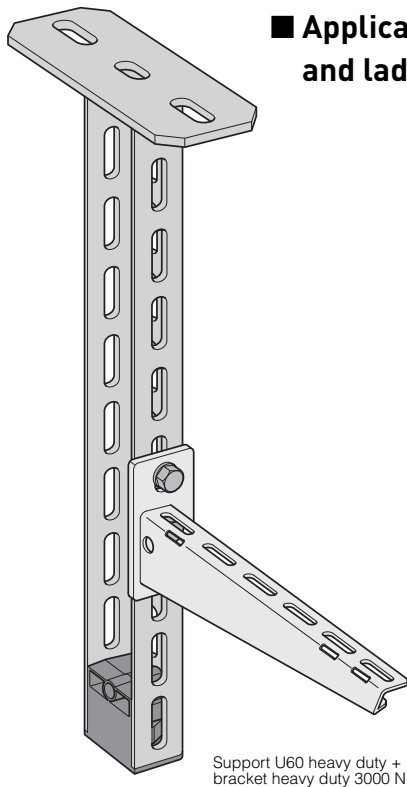

■ Applicable to both tray and ladder

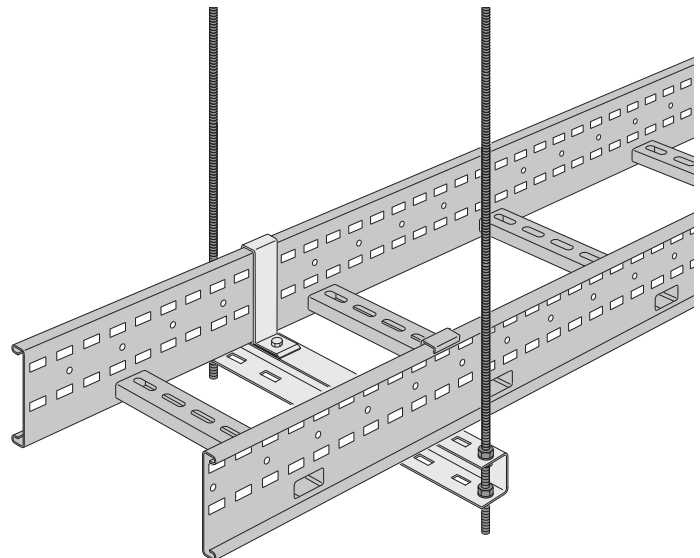

■ Brackets can be mounted on to supports and onto walls

SUPPORTING SYSTEMS

The supporting systems range can be divided into the following applications:

- > Ceiling supports
- > Brackets (wall, clamping or supporting brackets)
- > Threaded rod suspensions

Legrand has tested the supports and brackets in compliance with DIN VDE-E 0639 part 1 and in accordance with the newest standard IEC 61537.

When fixing the supporting constructions, always take the load that is applied to the constructional part into consideration.

■ Programme

The supporting systems programme can be divided into the following parts:

- ceiling supports
- brackets (wall, clamping or supporting brackets)
- threaded rod suspensions

For optimum ease of searching, the supporting systems have been classified in the catalogue as follows:

① Ceiling system

U55 (Medium duty)



U60 (Heavy duty)

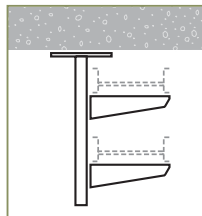

I-80 (Extra heavy duty)

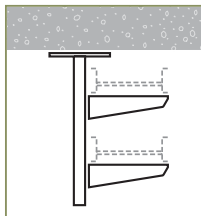

Trapeze hangers

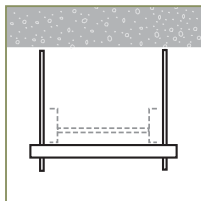

Hanger rod brackets

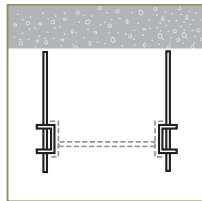

② Wall mounting

Bracket (3000 N)

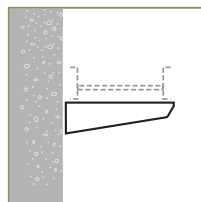

Bracket (6000 N)

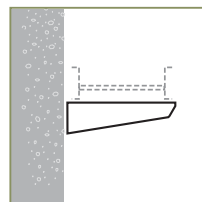

Loading graphs

■ Load on supports or brackets

The choice for the correct support system depends on the ladder load and the support distance as found in the loading graphs. The load on each supporting point can be calculated as:







(Cable load N/m + ladder weight⁽¹⁾ N/m) x Span (m)

(1) for ladder weight see table page 52

Example: for the ladder H100 W600 (ladder weight 55 N/m, with safe working load of 1050 N/m and span of 4,5 m:
 $(1050 \text{ N/m} + 55 \text{ N/m}) \times 4,5\text{m} = 4972,5 \text{ Newton}$.

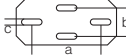
A bracket of support systems will therefore need to be able to support this load.

■ Technical data ceiling supports

	U55	U60	I-80
Moment 1% bending outwards	320 Nm	780 Nm	1440 Nm
Symmetrical load	3500 N	6000 N	10.000
Head plate data			
a (mm)	120	135	135
b (mm)	43	80	50
c (mm)	11	14	14
Profile data			
Moment	480 Nm	1200 Nm	2250 Nm
Dimensions	50 x 36 x 12 x 2	60 x 40 x 4	80 x 42
Ix cm ⁴	10,62	20,8	77,8
Wx cm ⁴	4,23	6,93	19,5
Iy cm ⁴	4,76	6,96	6,29
Wy cm ⁴	2,23	2,61	3,0
Profile perforation	35x8,5 centre-to-centre 50	40x11 centre-to-centre 50	75x24 centre-to-centre 100
Finishing	hot dip galvanised	hot dip galvanised	hot dip galvanised

■ Choice of ceiling support

The diagram below shows the correct ceiling support for any given size and load of bracket:

Example:

Ladder H = 100 mm, B = 300 mm with a span of 4 meters.

(Practical cable load N/m + ladder weight⁽¹⁾ N/m) x Span (m) = Load on bracket (N)

(1) for ladder weight see table page 52

$$(7 \times 30 \times 25) + 45 = 570 \text{ N/m} \times 4 \text{ m} = 2280 \text{ N}$$

To find the suitable ceiling support, draw a line straight down from the 2280 N mark on the top axis straight down. Also draw a line from the left axis (ladder width 300 mm) straight to the right. The intersection of these two lines is in the area of the suitable support, in this case in the blue area of the U60 support.

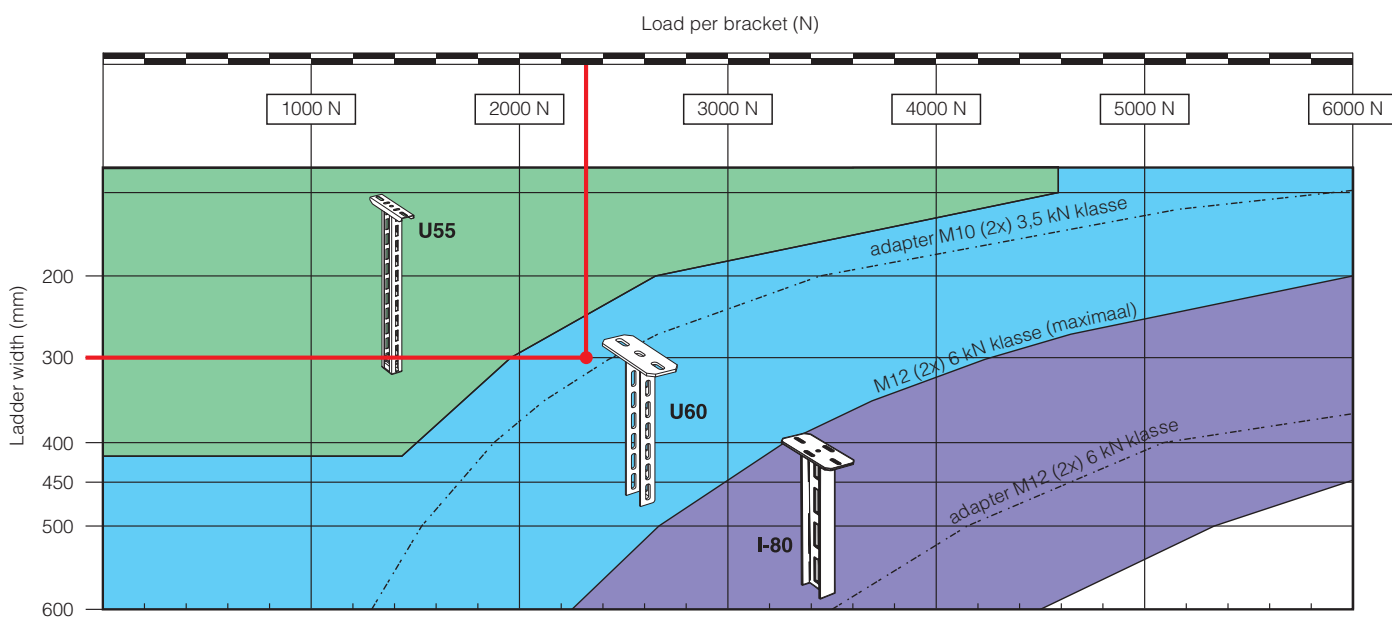

General notes:

- It is not allowed to:
 - Walk across a cable ladder installation
 - Let ladders, scaffolding or other objects lean on a cable ladder installation
- The loads shown in all graphs are the safe recommended maximum loads that can be applied and must include wind, snow and any other external forces in addition to the cable load.
- Fittings do not need separate supporting (unless W>600mm)
- When designing and fixing support constructions, the load on the total structure (building) must be taken into account.

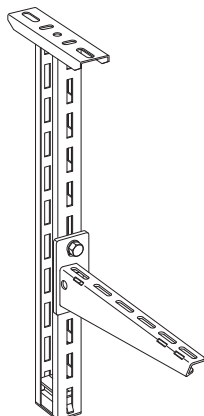

Support U55

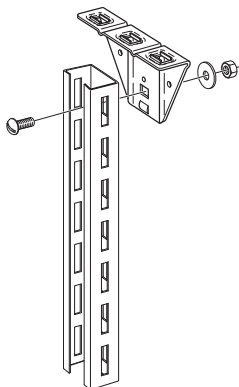

Profile U55



Technical information (page 70)

Packaging	Ref.no.	Support U55
		Support U55 medium duty Moment 1% deflection 320 Nm Symmetrical load 3500 N Including protection cap ref.no. 87064 01 Length
1	87664 02	200 mm
1	87664 03	300 mm
1	87664 04	400 mm
1	87664 05	500 mm
1	87664 06	600 mm
1	87664 07	700 mm
1	87664 08	800 mm
1	87664 09	900 mm
1	87664 10	1000 mm
1	87664 11	1100 mm
1	87664 12	1200 mm
		Profile U55 medium duty Moment 480 Nm
4	87664 45	4500 mm
		Top fixing plate U50/U55 2000 N Lock to profile with 1x M8 x 35 mm carriage bolt + washer + hexagon nut
20	87695 01	
		Profile connector U50/U55 Lock to profile with 8x M8 x 35 mm carriage bolt + washer + hexagon nut
10	87695 02	
		End cap U50/U55 Plastic, yellow Protection for support end
1	87064 01	

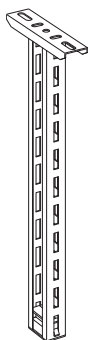

Packaging	Ref.no.	Support U55 (continued)
		Bracket heavy duty 3000 N Fix to profile U55 with 1x M8 x 20 mm hexagon bolt + washer + hexagon nut Width
1	5572 33	200 mm
1	5572 43	300 mm
1	5572 53	400 mm
1	5572 63	500 mm
1	5572 73	600 mm
1	5573 83	700 mm

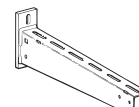

Packaging	Ref.no.	Fixing materials
		Carriage bolt M8 x 35 mm
100	80699 41	
		Hexagon bolt M8 x 20 mm
100	80699 03	
		Hexagon nut M8
100	80699 07	
		Washer 8,4 x 25 x 2 mm
100	80699 43	



Accessories (page 67)

universal supporting systems ceiling system

U60

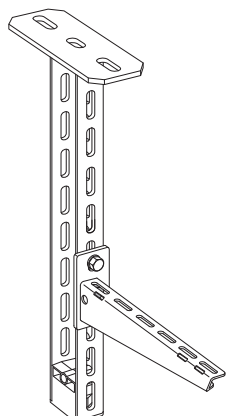

Support U60

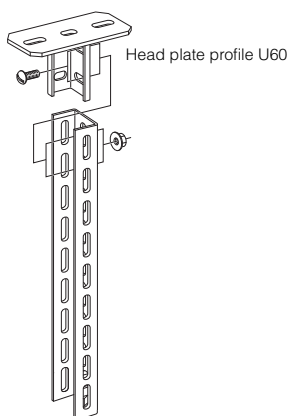

Profile U60



Technical information (page 70)

Packaging	Ref.no.	Support U60
		Support U60 heavy duty Moment 1% deflection 780 Nm Symmetrical load 6000 N Including protection cap ref.no. 87064 02 Length
6	87665 02	200 mm
10	87665 03	300 mm
1	87665 04	400 mm
1	87665 05	500 mm
1	87665 06	600 mm
1	87665 07	700 mm
1	87665 08	800 mm
1	87665 09	900 mm
1	87665 10	1000 mm
1	87665 11	1100 mm
1	87665 12	1200 mm
1	87665 13	1300 mm
1	87665 14	1400 mm
1	87665 15	1500 mm
1	87665 16	1600 mm
1	87665 18	1800 mm
1	87665 20	2000 mm
		Profile U60 heavy duty Moment 1200 Nm
1	87665 30	3000 mm
1	87665 45	4500 mm
		Ceiling bracket U60 6000 N Lock to profile with 2x M10 x 25 mm carriage bolt + washer + hexagon nut Adjustable between -30° and +30°
10	87665 50	
		End plate profile U60 6000 N Lock to profile with 2x M10 x 25 mm carriage bolt + washer + hexagon nut
10	87665 60	
		Profile connector U60 profile Lock to profile with 4x M10 x 20 mm hexagon bolt + washer + hexagon nut
10	87665 70	
		End cap U60 Plastic, yellow Protection for support end
1	87064 02	

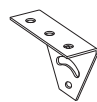
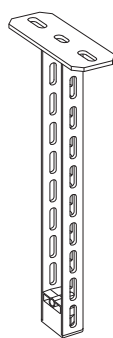

Packaging	Ref.no.	Support U60 (continued)
		Bracket heavy duty 3000 N Fix to profile U60 with 1x M10 x 25 mm carriage bolt + washer + hexagon nut Width
1	5572 33	200 mm
1	5572 43	300 mm
1	5572 53	400 mm
1	5572 63	500 mm
1	5572 73	600 mm
1	5573 83	700 mm
		Wall bracket
		Width Height Max. load
1	80606 25	250 mm 120 mm 6000 N
1	80606 30	300 mm 120 mm 6150 N
1	80606 35	350 mm 120 mm 6300 N
1	80606 40	400 mm 120 mm 6500 N
1	80606 45	450 mm 162 mm 6700 N
1	80606 50	500 mm 162 mm 6900 N
1	80606 55	550 mm 162 mm 7100 N
1	80606 60	600 mm 162 mm 7300 N
1	80606 65	650 mm 162 mm 7500 N
1	80606 70	700 mm 162 mm 7700 N
1	80606 75	750 mm 210 mm 7900 N
1	80606 85	850 mm 210 mm 8100 N
1	80606 90	900 mm 210 mm 8300 N
1	80606 91	950 mm 210 mm 8500 N
1	80606 96	1050 mm 210 mm 8800 N

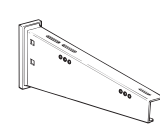
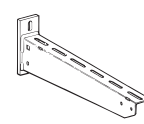

Packaging	Ref.no.	Fixing materials
		Carriage bolt M10 x 25 mm
100	80699 35	
		Hexagon bolt M10 x 20 mm
100	80699 20	
		Hexagon nut M10
100	80699 06	
		Washer 10,5 x 21 x 2 mm
100	80699 09	



Accessories (page 67)

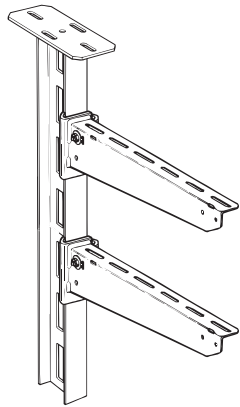

Support I-80



87668 03



87068 00



87668 82



Technical information (page 70)

Packaging	Ref.no.	Support I-80
		Support I-80 extra heavy duty Moment 1% deflection 1440 Nm Symmetrical load 10000 N Heavy duty support for single- and double-sided suspension of clamping brackets Length
1	87668 02	200 mm
1	87668 03	300 mm
1	87668 04	400 mm
1	87668 05	500 mm
1	87668 06	600 mm
1	87668 07	700 mm
1	87668 08	800 mm
1	87668 09	900 mm
1	87668 10	1000 mm
1	87668 12	1100 mm
1	87668 14	1400 mm
1	87668 16	1600 mm
1	87668 18	1800 mm
1	87668 20	2000 mm
		Profile I-80 extra heavy duty Moment 2250 Nm Symmetrical load 10000 N To be applied to heavy duty supporting constructions combined with I-80 items Other lengths possible upon request
1	87667 02	200 mm
1	87667 03	300 mm
1	87667 04	400 mm
1	87667 05	500 mm
1	87667 06	600 mm
1	87667 07	700 mm
1	87667 08	800 mm
1	87667 09	900 mm
1	87667 10	1000 mm
1	87667 30	3000 mm
1	87667 60	6000 mm

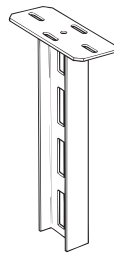

Packaging	Ref.no.	Support I-80 (continued)
10	87668 81	Head plate I-80 For horizontal ceilings Including fixing material
10	87668 86	Head plate transverse I-80 For horizontal ceilings Including fixing material
5	87668 82	Adjustable head plate I-80 For non-horizontal ceilings Including fixing material
5	87668 87	Adjustable head plate transverse I-80 For non-horizontal ceilings Including fixing material
20	87668 85	Connector transverse I-80 Including fixing material
20	87668 84	Profile connector I-80 Including fixing material
1	87668 83	Wall/floor/ceiling angle I-80 Including fixing material
1	87634 70	Adapter I-80 For increasing the distance between anchor bolts, for heavier loads
25	87068 00	End cap I-80 Plastic, yellow Protection for support end

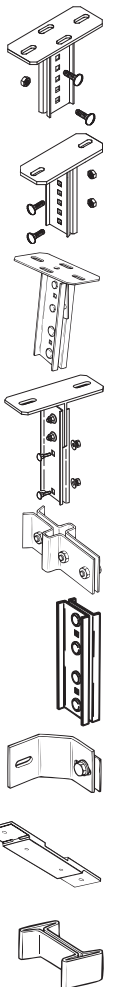

universal supporting systems ceiling system

I-80 (continued)



80607 30

Packaging Ref.no. **Support I-80 (continued)**

Packaging	Ref.no.	Description
		Bracket heavy duty 3000 N
		Fix to profile I-80 with clamp ref.no. 5572 03
		Width
1	5572 33	200 mm
1	5572 43	300 mm
1	5572 53	400 mm
1	5572 63	500 mm
1	5572 73	600 mm
1	5573 83	700 mm
		I-80 clamp
1	5572 03	To fix bracket heavy duty to I-80 support Bracket width 200 - 500: 1 piece Bracket width 600 - 700: 2 pieces
		Clamping bracket for I-80 support
		Including fixing materials
1	80607 25	250 mm 120 mm 6000 N
1	80607 30	300 mm 120 mm 6150 N
1	80607 35	350 mm 120 mm 6300 N
1	80607 40	400 mm 120 mm 6500 N
1	80607 45	450 mm 162 mm 6700 N
1	80607 50	500 mm 162 mm 6900 N
1	80607 55	550 mm 162 mm 7100 N
1	80607 60	600 mm 162 mm 7300 N
1	80607 65	650 mm 162 mm 7500 N
1	80607 70	700 mm 162 mm 7700 N
1	80607 75	750 mm 210 mm 7900 N
1	80607 85	850 mm 210 mm 8100 N
1	80607 90	900 mm 210 mm 8300 N
1	80607 91	950 mm 210 mm 8500 N
1	80607 96	1050 mm 210 mm 8800 N
		Beamclamp
1	80600 32	To fix a support directly onto a structural beam 6000 N per clamp, lock with 2x M10 x 80 mm hexagon screw + nut + washer (ref.no. 80699 00 + 80699 06 + 80699 09)

universal supporting systems ceiling system

technical information I-80

■ The I-80 fixing support

The I-80 fixing support is suitable for single- and double-sided loads. When with one-sided bracket mounting the load moment exceeds $M = 900 \text{ Nm}$, it is advisable to apply a cross support in order to obtain a stable suspension.

The load moment can be obtained as follows:

P = load on bracket (Newton)

b = bracket width (metres)

$$M = (P_1 \times b_1/2) + (P_2 \times b_2/2) + (P_3 \times b_3/2) + \text{etc.}$$

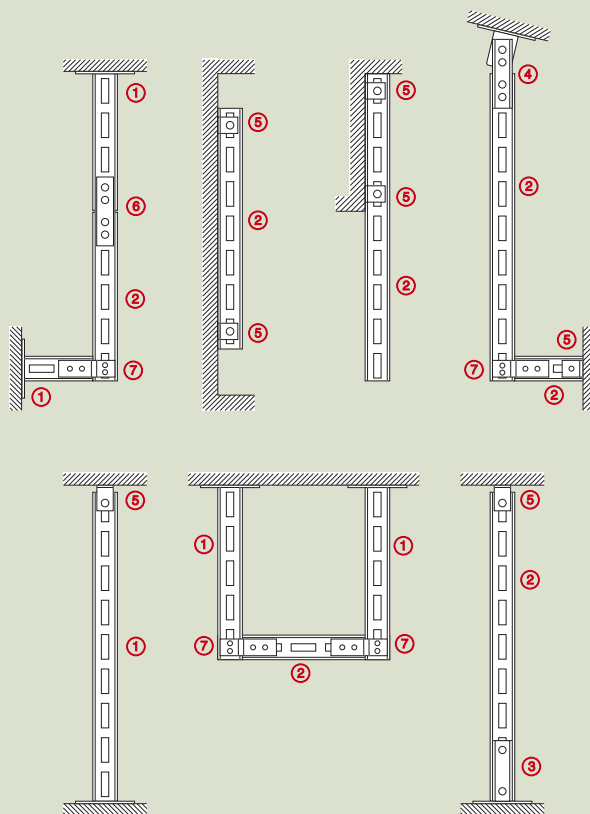
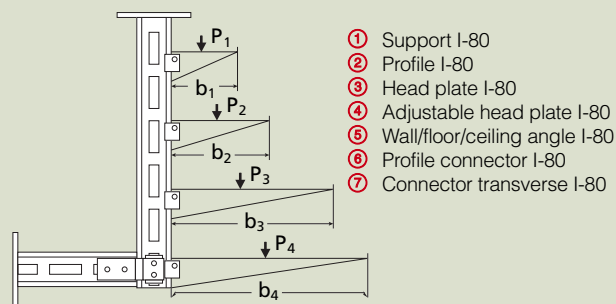

Accessories (page 67)

universal supporting systems ceiling system Trapeze hanger

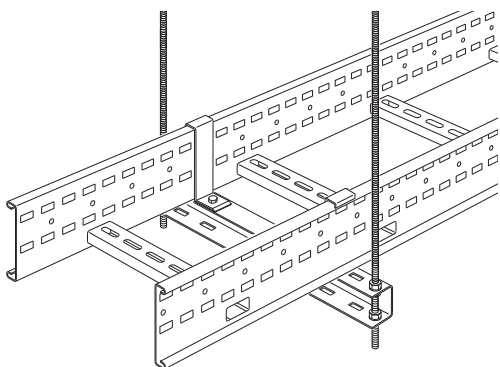

Trapeze hanger

universal supporting systems ceiling system Hanger rod bracket

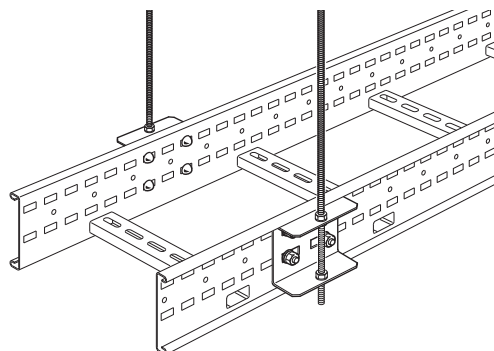

Trapeze rod brackets



Technical information (page 70)

Packaging	Ref.no.	Trapeze hanger										
		Light duty trapeze hangers Supplied singly without fastenings Support horizontal light duty ladder from overhead structures Use M10 threaded rods										
		<table border="1"> <thead> <tr> <th>Length</th> <th>Max. load</th> </tr> </thead> <tbody> <tr> <td>225 mm</td> <td>2000 N</td> </tr> <tr> <td>300 mm</td> <td>2700 N</td> </tr> <tr> <td>450 mm</td> <td>3000 N</td> </tr> </tbody> </table>	Length	Max. load	225 mm	2000 N	300 mm	2700 N	450 mm	3000 N		
Length	Max. load											
225 mm	2000 N											
300 mm	2700 N											
450 mm	3000 N											
1	LTH 225 G											
1	LTH 300 G											
1	LTH 450 G											
		Heavy duty trapeze hangers Supplied singly without fasteners Support horizontal runs of ladder from overhead structure Use M10 threaded rods										
		<table border="1"> <thead> <tr> <th>Length</th> <th>Max. load</th> </tr> </thead> <tbody> <tr> <td>200 mm</td> <td>4000 N</td> </tr> <tr> <td>300 mm</td> <td>4000 N</td> </tr> <tr> <td>450 mm</td> <td>4000 N</td> </tr> <tr> <td>600 mm</td> <td>5000 N</td> </tr> </tbody> </table>	Length	Max. load	200 mm	4000 N	300 mm	4000 N	450 mm	4000 N	600 mm	5000 N
Length	Max. load											
200 mm	4000 N											
300 mm	4000 N											
450 mm	4000 N											
600 mm	5000 N											
1	HTH 200 G											
1	HTH 300 G											
1	HTH 450 G											
1	HTH 600 G											
		<i>Load data apply only when fixed according to instructions on page 73!</i>										
1	82621 00	Ceiling bracket universal M10 2500 N M10										
25	82640 00	Threaded rod M10 5800 N M10 Length 1000 mm										
		Fixing materials										
100	80699 06	Hexagon nut M10										
100	80699 09	Washer 10,5 x 21 x 2 mm										



Technical information (page 70)

Packaging	Ref.no.	Hanger rod bracket						
		Hanger rod brackets When hanger rod brackets are fitted to ladder, covers can not be used Supplied in pairs with bracket to ladder fasteners Support horizontal runs of ladder from overhead structure Use M10 threaded rods						
		<table border="1"> <thead> <tr> <th>Light duty H</th> <th>Max. load</th> </tr> </thead> <tbody> <tr> <td>50 mm</td> <td>1000 N/pair</td> </tr> <tr> <td>100 mm</td> <td>4000 N/pair</td> </tr> </tbody> </table>	Light duty H	Max. load	50 mm	1000 N/pair	100 mm	4000 N/pair
Light duty H	Max. load							
50 mm	1000 N/pair							
100 mm	4000 N/pair							
1	ORB GZ							
1	ZRB GZ							
		<i>Load data apply only when fixed according to instructions on page 73!</i>						
1	82621 00	Ceiling bracket universal M10 2500 N M10						
25	82640 00	Threaded rod M10 5800 N M10 Length 1000 mm						
1	FL2	Beam clamp for M10 Max. load 2400 N						
		Fixing materials						
100	80699 06	Hexagon nut M10						
100	80699 09	Washer 10,5 x 21 x 2 mm						

Accessories (page 67)

Accessories (page 67)

universal supporting systems

wall mounting

Wall brackets



universal supporting systems

accessories



80606 30



ZWSB GZ

Technical information (page 70)

Wall Brackets

Packaging	Ref.no.	Width	Height	Max. load
1	5572 33	200 mm		
1	5572 43	300 mm		
1	5572 53	400 mm		
1	5572 63	500 mm		
1	5572 73	600 mm		
1	5573 83	700 mm		
Bracket heavy duty 3000 N				
Width				
1	80606 25	250 mm	120 mm	6000 N
1	80606 30	300 mm	120 mm	6150 N
1	80606 35	350 mm	120 mm	6300 N
1	80606 40	400 mm	120 mm	6500 N
1	80606 45	450 mm	162 mm	6700 N
1	80606 50	500 mm	162 mm	6900 N
1	80606 55	550 mm	162 mm	7100 N
1	80606 60	600 mm	162 mm	7300 N
1	80606 65	650 mm	162 mm	7500 N
1	80606 70	700 mm	162 mm	7700 N
1	80606 75	750 mm	210 mm	7900 N
1	80606 85	850 mm	210 mm	8100 N
1	80606 90	900 mm	210 mm	8300 N
1	80606 91	950 mm	210 mm	8500 N
1	80606 96	1050 mm	210 mm	8800 N
Bracket extra heavy duty 6000 N				
Width				
Height				
Max. load				
Wall support bracket				
Supplied in pairs with fasteners				
For vertical ladder installation				
1	OWSB GZ	Light duty H 50 mm		
1	ZWSB GZ	Medium duty H 100 mm		
1	PWSB GZ	Heavy duty H 125 mm		
1	EWSB GZ	Extra heavy duty H 150 mm		

Technical information (page 70)

Packaging	Ref.no.	Accessories
10	OF G	Hold down clip
10	ZF G	Supplied singly without fasteners
10	PF G	Fits ladder to flat surfaces, Swiftrack channel or heavy duty trapeze hangers which have slots in the top flange to accept fasteners
10	EF G	Light duty H 50 mm
		Medium duty H 100 mm
		Heavy duty H 125 mm
		Extra heavy duty H 150 mm
		Hold down bracket
		Supplied singly without fasteners
		Fits ladder to flat surfaces, Swiftrack channel, cantilever arms or heavy duty trapeze hangers which have slots in the top flange to accept fasteners
10	OJ G	Light duty H 50 mm
10	ZJ G	Medium duty H 100 mm
10	PJ G	Heavy duty H 125 mm
10	EJ G	Extra heavy duty H 150 mm
		Boltable hold down bracket
		Supplied singly with bracket to ladder fastener
		Fits ladder to Swiftrack channel in fabricated steel support structure
1	ZN GZ	Medium duty H 100 mm
1	PN GZ	Heavy duty H 125 mm
1	EN GZ	Extra heavy duty H 150 mm
		Boltable angled hold down brackets
		Supplied in handed pairs with bracket to ladder fastener
		Fits ladder to heavy duty cantilever arms and trapeze hangers which have slots in the side flange to accept fasteners
1	ZP GZ	Medium duty H 100 mm
1	PP GZ	Heavy duty H 125 mm
1	EP GZ	Extra heavy duty H 150 mm
		End connectors
		Pair supplied with fasteners
1	OB GZ	Light duty H 50 mm
1	ZB GZ	Medium duty H 100 mm
1	PB GZ	Heavy duty H 125 mm
1	EB GZ	Extra heavy duty H 150 mm
		Beam fixing clamp
1	80600 35	For fixing a ladder on a structural beam

universal supporting systems ceiling system

Trapeze hanger

SS
316 L

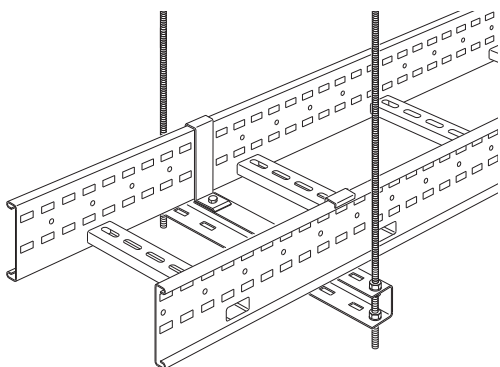

Trapeze hanger

universal supporting systems ceiling system

Hanger rod bracket

SS
316 L

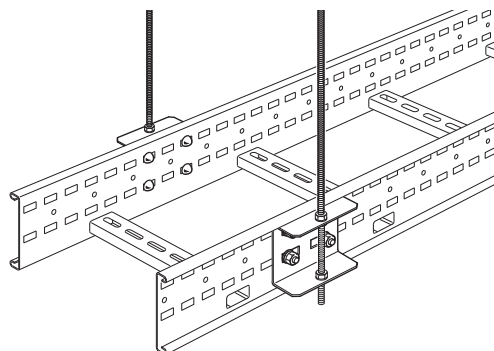

Trapeze rod brackets



Technical information (page 70)

Packaging	Ref.no.	Trapeze hanger										
		<p>Heavy duty trapeze hangers Supplied singly without fasteners Support horizontal runs of ladder from overhead structure Use M10 threaded rods</p> <table border="1"> <thead> <tr> <th>Length</th> <th>Max. load</th> </tr> </thead> <tbody> <tr> <td>200 mm</td> <td>4000 N</td> </tr> <tr> <td>300 mm</td> <td>4000 N</td> </tr> <tr> <td>450 mm</td> <td>4000 N</td> </tr> <tr> <td>600 mm</td> <td>5000 N</td> </tr> </tbody> </table> <p><i>Load data apply only when fixed according to instructions on page 73!</i></p>	Length	Max. load	200 mm	4000 N	300 mm	4000 N	450 mm	4000 N	600 mm	5000 N
Length	Max. load											
200 mm	4000 N											
300 mm	4000 N											
450 mm	4000 N											
600 mm	5000 N											
1	HTH 200 S											
1	HTH 300 S											
1	HTH 450 S											
1	HTH 600 S											
		<p>Ceiling bracket universal M10 2000 N M10</p>										
1	4185-0101											
		<p>Threaded rod 5800 N</p> <table border="1"> <thead> <tr> <th>Length</th> </tr> </thead> <tbody> <tr> <td>1000 mm</td> </tr> </tbody> </table>	Length	1000 mm								
Length												
1000 mm												
25	4192-0100											

Packaging	Ref.no.	Fixing materials
		<p>Hexagon nut M10</p>
100	80499 06	
		<p>Washer 10,5 x 21 x 2 mm</p>
100	80499 09	

Accessories (page 69)



Technical information (page 70)

Packaging	Ref.no.	Hanger rod bracket		
		<p>Hanger rod brackets When hanger rod brackets are fitted to ladder, covers can not be used Supplied in pairs with bracket to ladder fasteners Support horizontal runs of ladder from overhead structure Use M10 threaded rods Medium duty H 100 mm 4000 N/pair</p> <p><i>Load data apply only when fixed according to instructions on page 73!</i></p>		
1	ZRB SZ			
		<p>Ceiling bracket universal M10 2000 N M10</p>		
1	4185-0101			
		<p>Threaded rod 5800 N</p> <table border="1"> <thead> <tr> <th>Length</th> </tr> </thead> <tbody> <tr> <td>1000 mm</td> </tr> </tbody> </table>	Length	1000 mm
Length				
1000 mm				
25	4192-0100			

Packaging	Ref.no.	Fixing materials
		<p>Hexagon nut M10</p>
100	80499 06	
		<p>Washer 10,5 x 21 x 2 mm</p>
100	80499 09	

Accessories (page 69)

universal supporting systems wall mounting

SS
316 L

Wall brackets



80406 30



ZWSB SZ



Technical information (page 70)

Brackets

Packaging	Ref.no.	Width	Height	Max. load
1	80406 25	250 mm	120 mm	6000 N
1	80406 30	300 mm	120 mm	6150 N
1	80406 35	350 mm	120 mm	6300 N
1	80406 40	400 mm	120 mm	6500 N
1	80406 45	450 mm	162 mm	6700 N
1	80406 50	500 mm	162 mm	6900 N
1	80406 55	550 mm	162 mm	7100 N
1	80406 60	600 mm	162 mm	7300 N
1	80406 65	650 mm	162 mm	7500 N
1	80406 70	700 mm	162 mm	7700 N
1	80406 75	750 mm	210 mm	7900 N
1	80406 85	850 mm	210 mm	8100 N
1	80406 90	900 mm	210 mm	8300 N
1	80406 91	950 mm	210 mm	8500 N
1	80406 96	1050 mm	210 mm	8800 N

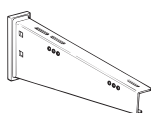

Wall support bracket

Supplied in pairs with fasteners
For rising ladder

1	ZWSB SZ	Medium duty H 100 mm
1	PWSB SZ	Heavy duty H 125 mm

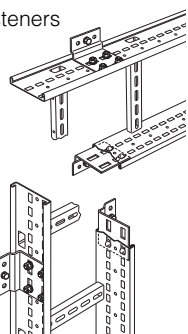

Accessories (page 69)

universal supporting systems accessories

SS
316 L



Technical information (page 70)

Accessories

Packaging	Ref.no.	Accessories
1	ZF S	Hold down clip Supplied singly without fasteners Fits ladder to flat surfaces, Swiftrack channel or heavy duty trapeze hangers which have slots in the top flange to accept fasteners H = 100 Standard
1	ZFIN SZ	Including insulating pad + bush H = 125
1	PF S	Standard
1	PFIN SZ	Including insulating pad + bush
1	ZJ S	Hold down bracket Supplied singly without fasteners Fits ladder to flat surfaces, Swiftrack channel, cantilever arms or heavy duty trapeze hangers which have slots in the top flange to accept fasteners H = 100 Standard
1	ZJIN SZ	Including insulating pad + bush H = 125
1	PJ S	Standard
1	PJIN SZ	Including insulating pad + bush
1	ZN SZ	Boltable hold down bracket Supplied singly with bracket to ladder fastener Fits ladder to Swiftrack channel in fabricated steel support structure Medium duty H 100 mm
1	PN SZ	Heavy duty H 125 mm
1	ZP SZ	Boltable angled hold down brackets Supplied in handed pairs with bracket to ladder fastener Fits ladder to heavy duty cantilever arms and trapeze hangers which have slots in the side flange to accept fasteners Medium duty H 100 mm
1	PP SZ	Heavy duty H 125 mm
1	ZB SZ	End connectors Pair supplied with fasteners Medium duty H 100 mm
1	PB SZ	Heavy duty H 125 mm
1	80400 35	Beam fixing clamp For fixing a ladder on a structural beam

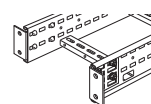
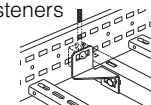
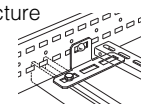
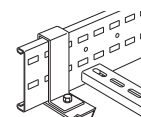
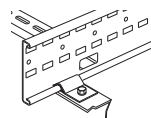

■ Dimensions

Support U55 medium heavy duty

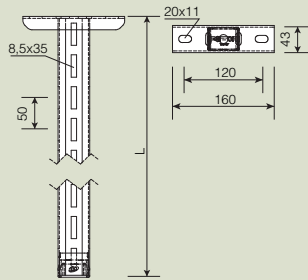

Profile U55 medium heavy duty

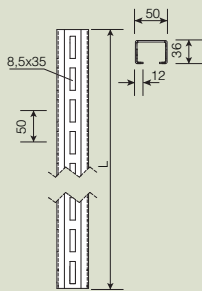

Top fixing plate U50/U55 2000 N

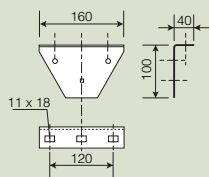

Support U60 heavy duty

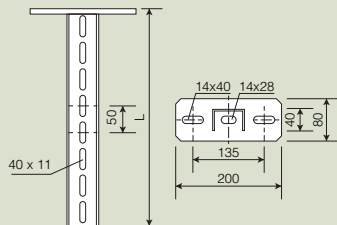

Profile U60 heavy duty

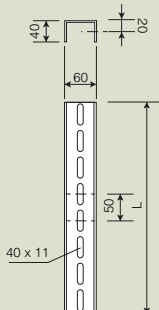

Ceiling bracket U60 6000 N

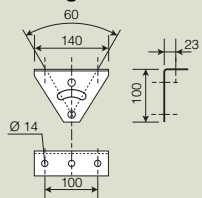

Head plate profile U60 6000 N

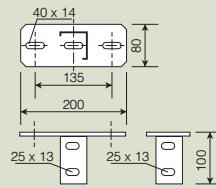

Profile connector U60

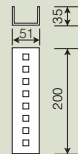

Support I-80 extra heavy duty

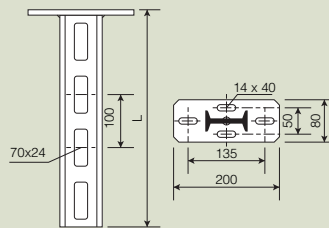

Profile I-80 extra heavy duty

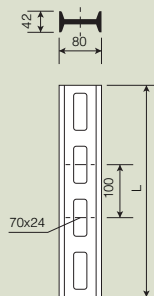

Wall/floor/ceiling angle I-80

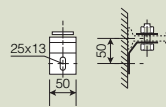

Head plate I-80

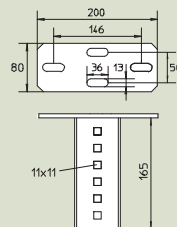

Head plate transverse I-80

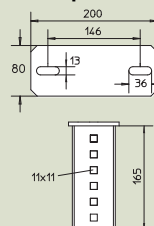

Adjustable head plate I-80

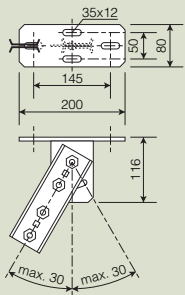

Adjustable head plate transverse I-80

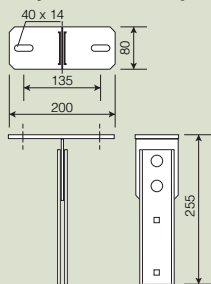

Connector transverse I-80

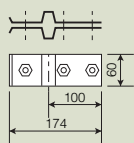

Profile connector I-80

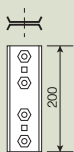

Adapter I-80

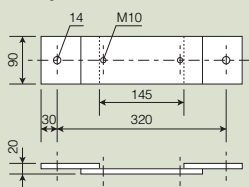

Bracket heavy duty 3000 N

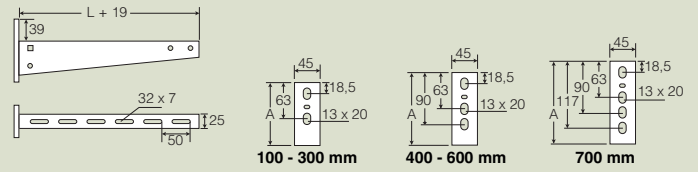

Type	A	Type	A	Type	A
100	93	400	121	700	146
200	103	500	128		
300	111	600	138		

Threaded rod

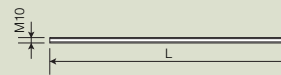

Ceiling bracket universal 2500 N

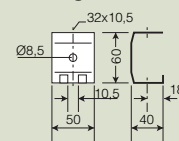

universal supporting systems

technical information *(continued)*

Hold down clip

Fits ladder to flat surfaces, Swiftrack channel or heavy duty trapeze hangers which have slots in the top flange to accept fasteners
Supplied singly without fasteners.
Insulated hold down clips are available for stainless steel ladder.
The table below gives the fixing hole spacing required when attaching hold down clips to other supports.

Type	Centre distance between fixing holes	Fixing Ø
OF	W + 35	M6
ZF	W + 95	M10
PF	W + 95	M10
EF	W + 95	M10

W = ladder width

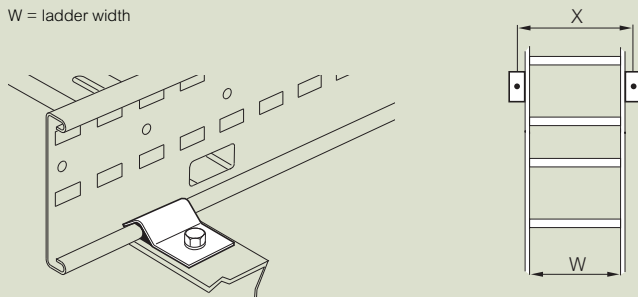

Hold down bracket

Fits ladder to flat surfaces, Swiftrack channel, cantilever arms or heavy duty trapeze hangers which have slots in the top flange to accept fasteners
Supplied singly without fasteners
Insulated hold down brackets are available for stainless steel ladder, contact us on 0845 605 4333
The table below gives the fixing hole spacing required when attaching hold down bracket to other supports

Type	Centre distance between fixing holes inside ladder Y	outside ladder X	Fixing Ø
OJ	W - 38	W + 62	M6
ZJ	W - 44	W + 80	M10
PJ	W - 44	W + 80	M10
EJ	W - 44	W + 80	M10

W = ladder width

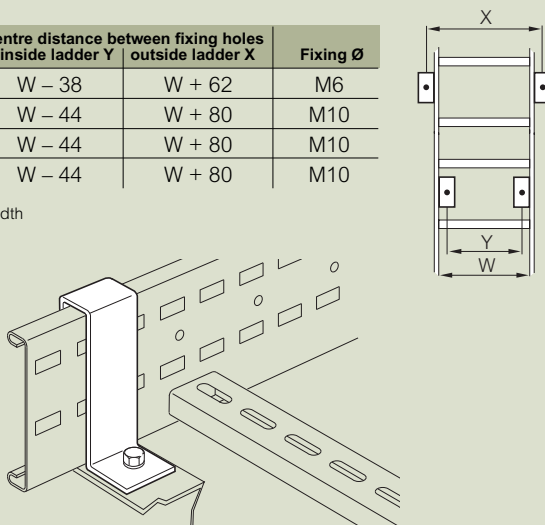

Bracket length for ladder with:

Light duty ladder H50 on 3000N brackets:

Ladder width	Hold down bracket (inside)	Hold down bracket (outside)	Hold down clip
200 mm	200	300	300
300 mm	300	400	400
450 mm	500	600	600
Type	OJ	OJ	OF

Medium duty ladder on 3000N bracket:

Ladder width	Hold down bracket (inside)
200 mm	300
300 mm	400
450 mm	500
600 mm	700
Type	ZJ

Medium/Heavy/Extra heavy duty ladder on extra heavy duty brackets 6000N:

Ladder width	Hold down bracket (inside)	Hold down bracket (outside)	Hold down clip
200 mm	250	350	350
300 mm	350	450	450
450 mm	500	600	600
600 mm	650	750	750
750 mm	850	900	900
900 mm	950	1050	1050
Type	ZJ / PJ / EJ	ZJ / PJ / EJ	ZF / PF / EF

Wall support brackets

Supplied in pairs with bracket to ladder fasteners
Fit horizontal or vertical runs of ladder to vertical surfaces and Swiftrack channel
Max. load: 3000 N/pair

OWSB	W+76
ZWSB	W+106
PWSB	W+106
EWSB	W+106

Boltable hold down bracket

Supplied singly with bracket to ladder fastener
Fit ladder to Swiftrack channel in fabricated steel support structure
Bracket to support fastener: M12

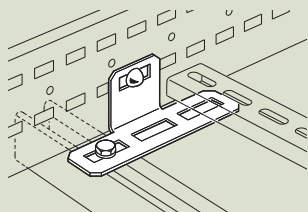

Boltable angled hold down brackets

Supplied in handed pairs with bracket to ladder fastener
Fit ladder to trapeze hangers which have slots in the side flange to accept fasteners

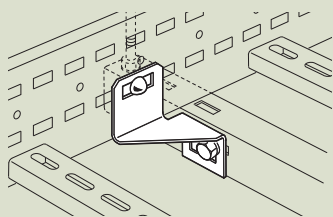

Trapeze hangers

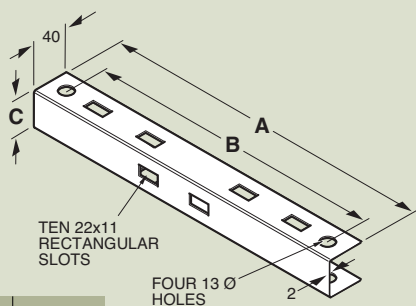

Ladder Width	A	B	C
200	400	360	40
300	500	460	40
450	650	610	50
600	800	760	60

Ladder to trapeze hanger fixing method

Use M10 threaded rods

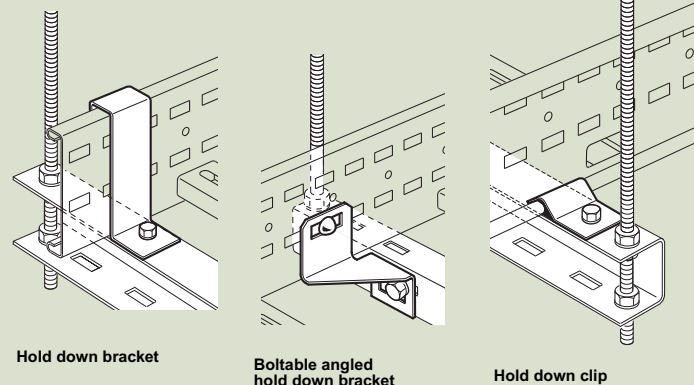

90° end connectors

Supplied in pairs with bracket to ladder fasteners
Fit ends of ladder to vertical surfaces

	A
OB	20
ZB	50
PB	75
EB	75

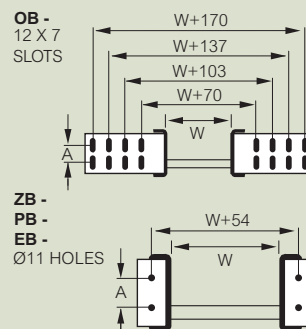

Hanger rod brackets

BRACKET TO LADDER

Brackets are fixed directly to the outside of the ladder siderail as shown. The slots in the side rail and the bracket provide sufficient movement to align the bracket with the threaded rod.

BRACKET TO THREADED ROD

Four nuts and washers are used to fix each bracket to the threaded rod. This ensures the stability of the support and also optimises the safe working load.

LOADING

When several levels of ladder are mounted on the same threaded rods, it is important to ensure that the total load on any pair of rods does not exceed the safe working load of the rods or their attachment points.

Light duty

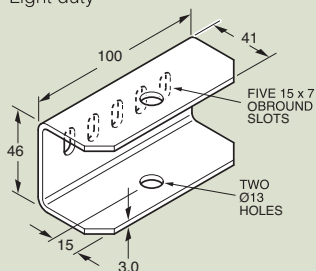

Medium duty

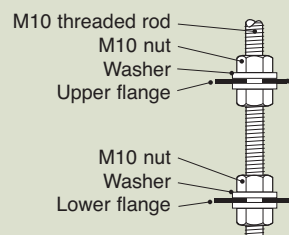
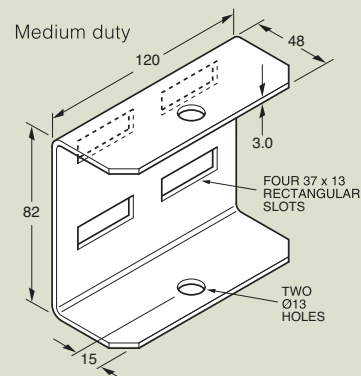

Load:
ORB: 1000 N/pair
ZRB: 4000 N/pair

Load data apply only when fixed according to this method

For flexible installation and support of trays and ladders

This complete range of mounting materials is universally applicable and can be mounted quickly and in all directions, even without welding or drilling. Swiftrack ensures quick installation that can easily be extended or adjusted. Products are easily dismantlable and this makes them available for reuse.

■ Programme:

Type	Length	Material/finishing
41 x 41 mm unperforated	3000 mm	Pregalvanised Hot dip galvanised Stainless steel 316
41 x 41 mm perforated	3000 mm	Pregalvanised Hot dip galvanised Stainless steel 316
41 x 21 mm unperforated	3000 mm	Pregalvanised Hot dip galvanised Stainless steel 316
41 x 21 mm perforated	3000 mm	Pregalvanised Hot dip galvanised Stainless steel 316
41 x 41 mm double	3000 mm	Hot dip galvanised Stainless steel 316

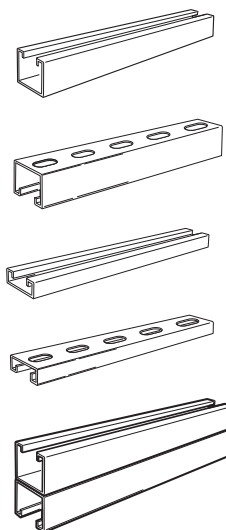

■ Characteristics

- Legrand offers a complete range of strut profiles and fixing brackets for flexible installation and support of cable management systems in various applications.
- Using these materials, a strong support construction can always be built without drilling or welding. Future adjustments and extensions are always possible and the system is easy to mount and reusable.
- The programme is available in pregalvanised, hot dip galvanised and stainless steel 316 versions, ensuring a suitable solution for any situation.

■ Swiftrack channel

- Flexible support of cable management systems

- Always a strong support construction



- Without drilling or welding

- Easy to mount

- Future adjustments and extensions are always possible

- Complete range of strut profiles and fixing brackets

- NEW standard in 3 m length



Swiftrack channel

loading graph

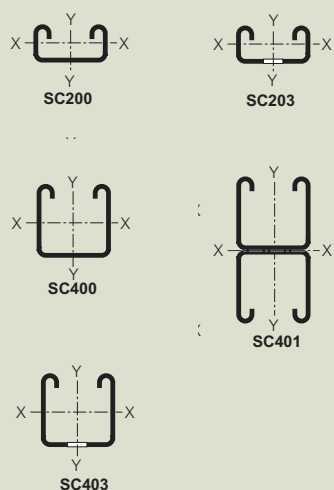

Cat. Nos.	Wt (kg/m)	A (mm ²)	I _{xx} (mm ⁴)	Z _{top} (min mm ³)	Z _{bottom} (max mm ³)	r _{xx} (mm)	I _{yy} (mm ⁴)	r _{yy} (mm)
SC 200 	1.8	219	10779	862	1330	7.1	49776	15.1
SC 203 	1.6	219	8960	794	961	6.4	49318	15.0
SC 400 	2.6	322	67157	2857	3772	14.5	88783	16.6
SC 403 	2.4	322	57221	2645	2909	13.3	88325	16.5
SC 401 	5.3	645	339300	8215	8215	23.0	177566	16.6

Wt = weight of section (kg/m)
 A = cross-sectional area (mm²)
 I_{xx} = moment of inertia = second moment of area (mm⁴)
 Z_{top} = section modulus about xx axis (mm³)
 Z_{bottom} = section modulus about xx axis (mm³)
 r_{xx} = radius of gyration (mm)
 I_{yy} = moment of inertia = second moment of area (mm⁴)
 r_{yy} = radius of gyration (mm)
 xx = about xx axis
 yy = about yy axis

Swiftrack channel

pregalvanised/ electro-galvanised



Technical information (page 79)



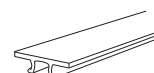
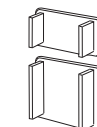
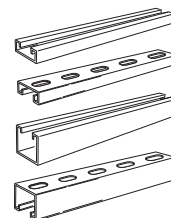











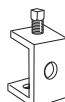



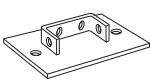



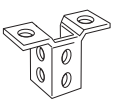

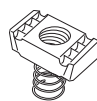





Packaging	Ref.no.	Pregalvanised/electro-galvanised
		Channel
		Length 3000 mm
1	SC 200 3M	41 x 21 mm Unperforated
1	SC 203 3M	41 x 21 mm Perforated
1	SC 400 3M	41 x 41 mm Unperforated
1	SC 403 3M	41 x 41 mm Perforated
		Long spring nut
100	PN 061	M6
100	PN 081	M8
100	PN 101	M10
100	PN 121	M12
		Short spring nut
100	PN 062	M6
100	PN 082	M8
100	PN 102	M10
100	PN 122	M12
		Plain nut
100	PN 060	M6
100	PN 080	M8
100	PN 100	M10
100	PN 120	M12
		End cap C-41 profile
1	SC 951 W	Plastic, white 41 x 21 mm
1	SC 950 W	41 x 41 mm
		Cover
1	SC 952	3000 x 31 mm Plastic, white



Swiftrack channel hot dip galvanised

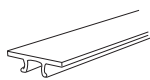

Technical information (page 79)

Packaging	Ref.no.	Hot dip galvanised	Packaging	Ref.no.	Hot dip galvanised (continued)	
1	SC 200 3M G	Channel Length 3000 mm 41 x 21 mm Unperforated 	1	SB 514	U-type clamp 137 x 21 mm 3x Ø 14 mm 	
1	SC 203 3M G		1	SB 515		
1	SC 400 3M G		1	SB 516		
1	SC 403 3M G		1	SB 517		
1	SC 401 3M G		1	SC 85241		Beam clamp Profile slides through the bracket Fixing by means of a clamping ring 41 x 41 mm 
1	SB 650	External jointing channel 41 x 21 mm 	1	SC 850	End beam clamp For fixing onto steel construction 	
1	SB 651		1	SC 851	Edge beam clamp Engages by means of clamping around 41 x 41 mm profile and the steel construction to be fixed 	
1	SB 50612	Flat fixing 1x Ø 14 mm 	1	SC 856	Beam clamp For fixing onto steel construction 	
1	SB 507		2x Ø 14 mm 	1	SB 705	U-base plate U-model For 2x C-profile 41 x 41 mm 
1	SB 508		3x Ø 14 mm 	1	SB 704	Single base plate 41 x 41 mm Corner model For 1x C-profile 41 x 41 mm 
1	SB 509		4x Ø 14 mm 	1	SB 700	T-bracket Opening = 43 x 41 mm, 8x Ø 14 mm 
1	SB 600	L-bracket 3x Ø 14 mm 	100	PN 061 G	Long spring nut M6 M8 M10 M12 	
1	SB 603	T-bracket 4x Ø 14 mm 	100	PN 081 G		
1	SB 501	Angled fixing 2x Ø 14 mm 	100	PN 101 G		
1	SB 502	3x Ø 14 mm 	100	PN 121 G		
1	SB 505	4x Ø 14 mm 	100	PN 062 G		Short spring nut M6 M8 M10 M12 
1	SB 504	4x Ø 14 mm 	100	PN 082 G	Plain nut M6 M8 M10 M12 	
1	SB 703	4x Ø 14 mm 	100	PN 102 G		
1	SB 513	Z-fixing bracket 2x Ø 14 mm 	100	PN 122 G		
1	SB 511	3x Ø 14 mm 	1	SC 951 W		End cap C-41 profile Plastic, white 41 x 21 mm 
1	SB 512	4x Ø 14 mm 	1	SC 950 W		41 x 41 mm 
1	SB 524	Angled bracket 45° 2x Ø 14 mm 	1	SC 952	Cover 3000 x 31 mm Plastic, white 	
1	SC 855	U-bolt beam clamp H = 90 mm 	1	SC 853	H = 45 mm 	

Technical information (page 79)

Stainless steel 316

Packaging	Ref.no.	Stainless steel 316
1	SC 200 3M S	Channel Length 3000 mm 41 x 21 mm Unperforated
1	SC 203 3M S	41 x 21 mm Perforated
1	SC 400 3M S	41 x 41 mm Unperforated
1	SC 403 3M S	41 x 41 mm Perforated
1	SC 401 3M S	41 x 41 mm Double
1	SB 650 S	External jointing channel 41 x 21 mm
1	SB 651 S	41 x 41 mm
1	SB 50612 S	Flat fixing 1x Ø 14 mm
1	SB 507 S	2x Ø 14 mm
1	SB 508 S	3x Ø 14 mm
1	SB 509 S	4x Ø 14 mm
1	SB 600 S	L-bracket 3x Ø 14 mm
1	SB 603 S	T-bracket 4x Ø 14 mm
1	SB 501 S	Angled fixing 2x Ø 14 mm
1	SB 502 S	3x Ø 14 mm
1	SB 505 S	4x Ø 14 mm
1	SB 504 S	4x Ø 14 mm
1	SB 703 S	4x Ø 14 mm
1	SB 513 S	Z-fixing bracket 2x Ø 14 mm
1	SB 511 S	3x Ø 14 mm
1	SB 512 S	4x Ø 14 mm
1	SB 524 S	Angled bracket 45° 2x Ø 14 mm
1	SC 855 S	U-bolt beam clamp H = 90 mm
1	SC 853 S	H = 45 mm

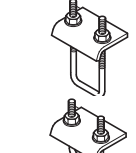
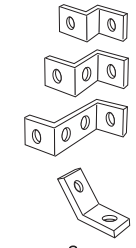
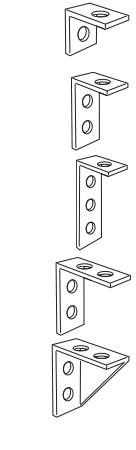
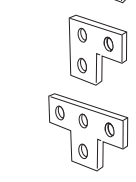
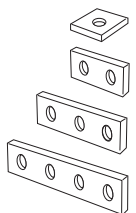
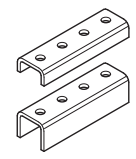
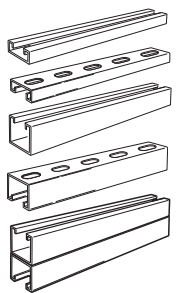

Packaging	Ref.no.
1	SB 514 S
1	SB 515 S
1	SB 516 S
1	SB 517 S
1	SC 85241 S
1	SC 850 S
1	SC 851 S
1	SC 856 S
1	SB 705 S
1	SB 704 S
1	SB 700 S
100	PN 061 S
100	PN 081 S
100	PN 101 S
100	PN 121 S
100	PN 062 S
100	PN 082 S
100	PN 102 S
100	PN 122 S
100	PN 060 S
100	PN 080 S
100	PN 100 S
100	PN 120 S
1	SC 951 W
1	SC 950 W
1	SC 952

Stainless steel 316 (continued)

U-type clamp

137 x 21 mm
3x Ø 14 mm
137 x 41 mm
3x Ø 14 mm
137 x 83 mm
3x Ø 14 mm
178 x 41 mm
4x Ø 14 mm

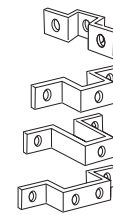

Beam clamp

Profile slides through the bracket
Fixing by means of a clamping ring
41 x 41 mm



End beam clamp

For fixing onto steel construction



Edge beam clamp

Engages by means of clamping around 41 x 41 mm profile and the steel construction to be fixed

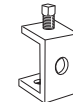

Beam clamp

For fixing onto steel construction



U-base plate

U-model
For 2x C-profile 41 x 41 mm

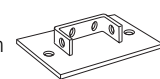

Single base plate

Corner model
For 1x C-profile 41 x 41 mm

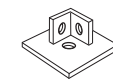

T-bracket

Opening = 43 x 41 mm,
8x Ø 14 mm



Long spring nut

M6
M8
M10
M12

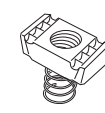

Short spring nut

M6
M8
M10
M12



Plain nut

M6
M8
M10
M12



End cap C-41 profile

Plastic, white
41 x 21 mm
41 x 41 mm

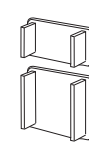

Cover

3000 x 31 mm
Plastic, white

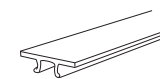

Swiftrack channel

technical information

External jointing channel

SB 650

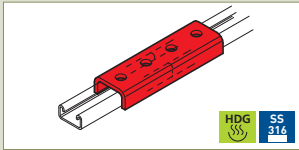

SB 651

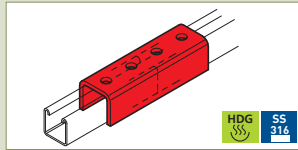

Flat fixing

SB 50612

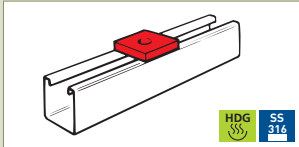

SB 507

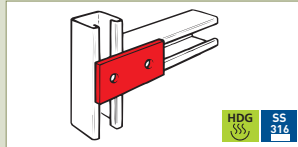

SB 508

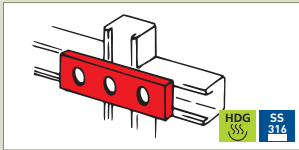

SB 509

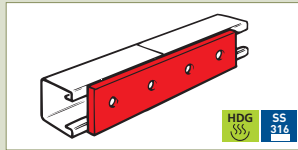

L-bracket

SB 600

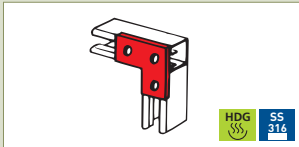

T-bracket

SB 603

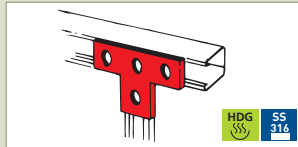

Angled fixing

SB 501

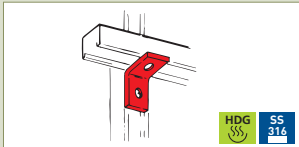

SB 502

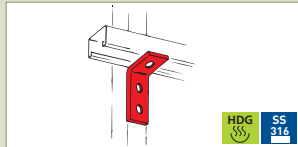

SB 505

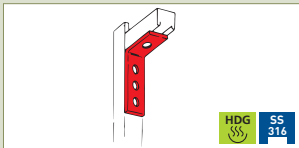

SB 504

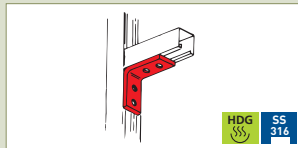

SB 703

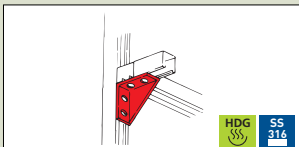

Z-shaped fixing bracket

SB 513

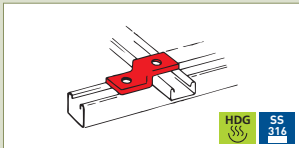

SB 511

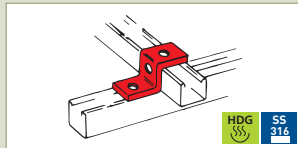

SB 512

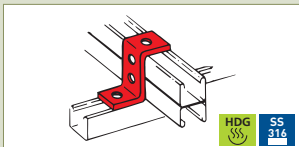

Angled bracket 45°

SB 524

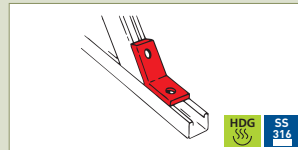

U-bolt beam clamp

SC 855 / SC 853

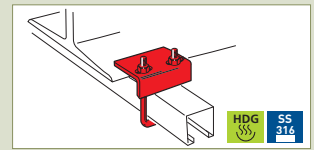

U-type clamp

SB 514

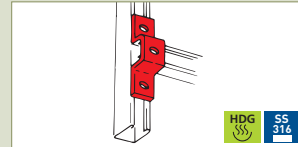

SB 515

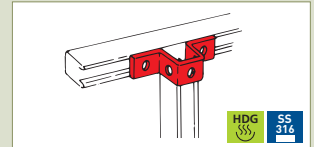

SB 516

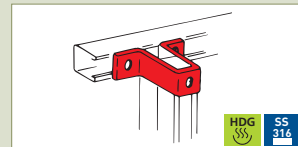

SB 517

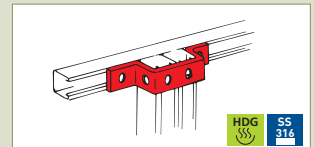

Beam clamp

SC 85241
41 x 41 mm

Profile slides through the bracket
Fixing by means of a clamping ring

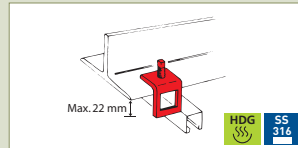

End beam clamp

SC 850

For fixing onto steel construction

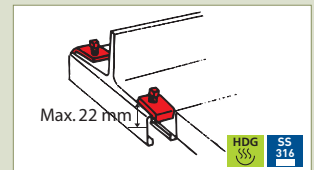

Edge beam clamp

SC 851

Engages by means of clamping around 41 x 41 mm profile and the steel construction to be fixed

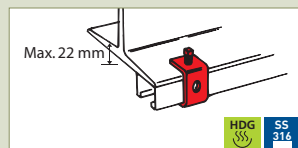

Beam clamp

SC 856

For fixing onto steel construction

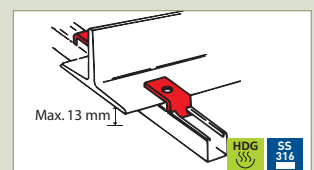

U-base plate

SB 705

U-model; 82 x 41 mm

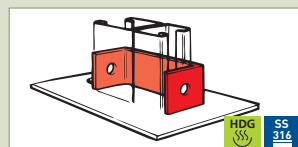

Single base plate

SB 704

Corner model; 41 x 41 mm

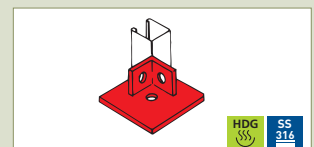

T-bracket

SB 700

Opening = 43 x 41 mm
8 x Ø 14 mm

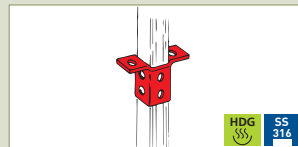

Swiftrack channel

technical information

■ Dimensions

C-profile

41 x 21 mm; unperforated

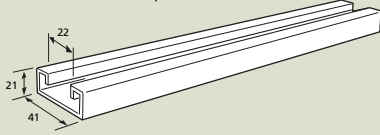

41 x 21 mm; perforated

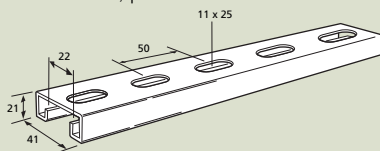

41 x 41 mm; unperforated

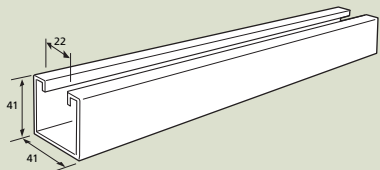

41 x 41 mm; perforated

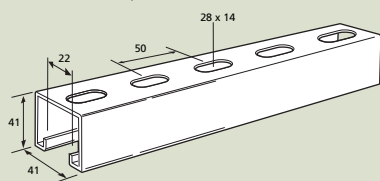

41 x 41 mm; double

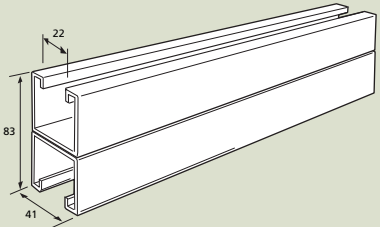

External jointing channel

SB 650; 41 x 21 mm

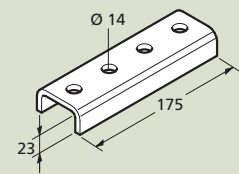

SB 651; 41 x 41 mm

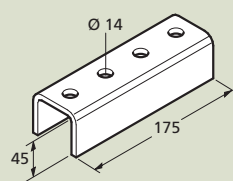

Flat fixing

SB 50612; 40 x 40 mm

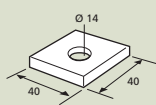

SB 507; 85 x 40 mm

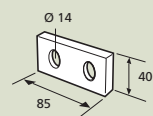

SB 508; 130 x 40 mm

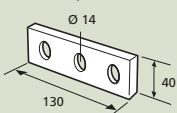

SB 509; 220 x 40 mm

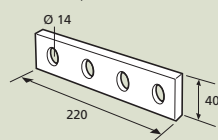

L-bracket

SB 600; 80 x 80/40 mm

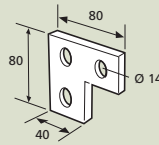

T-bracket

SB 603; 120 x 80/40 mm

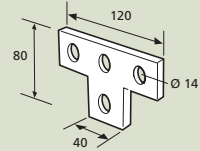

Angled fixing

SB 501; 54 x 40 mm

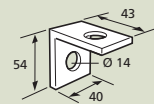

SB 502; 99 x 40 mm

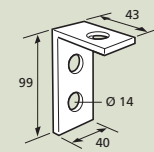

SB 505; 137 x 40 mm

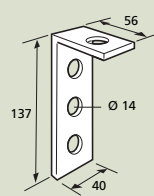

SB 504; 99 x 88 mm

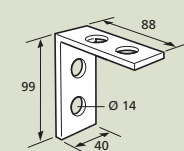

SB 703; 99 x 88 mm

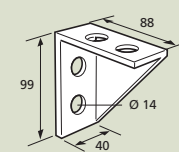

Z-fixing bracket

SB 513; 21 x 40 mm

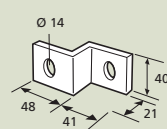

SB 511; 41 x 40 mm

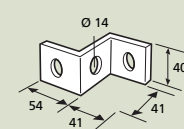

SB 512; 83 x 40 mm

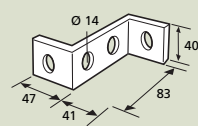

Angled bracket 45°

SB 524

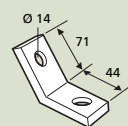

U-bolt beam clamp

SC 855

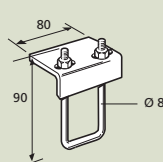

SC 853

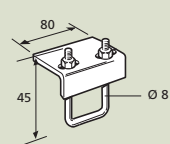



COLRING™ CABLE TIES

Protected against UV-radiation

■ Resistant to high temperatures:

Permanently 20000 h: 105 °C

Continuously 1000 h: 120 °C

Max. allowed: 150 °C



■ Resistant to low temperatures:

Use: -40 °C

Mounting: 0 °C

COLRING CABLE TIES

> Corrosivity of the flue gasses: UTE C 20 452 octane 76, < 5%

> Halogen-free

> Moisture absorption < 1 %

> Flame resistance: UL 94 V 2

> Resistance against external influences:

- Limited resistance to acids

- Good resistance to bases, oils, greases petrochemical products, chlorine containing solvents

U-type clamp

SB 514; 141 x 21 mm

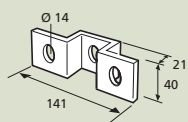

SB 515; 141 x 41 mm

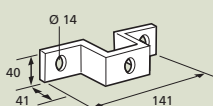

SB 516; 141 x 82 mm

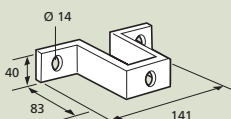

SB 517; 193 x 41 mm

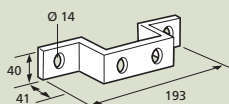

Beam clamp

SC 85241

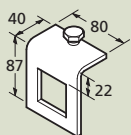

End beam clamp

SC 850

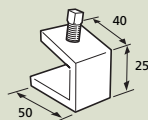

Edge beam clamp

SC 851

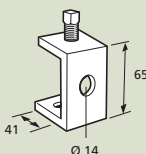

Beam clamp

SC 856

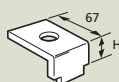

U-base plate

SB 705

U-model; 82 x 41 mm

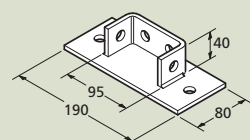

Single base plate

SB 704

Corner model; 41 x 41 mm

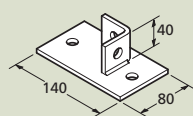

T-bracket

SB 700

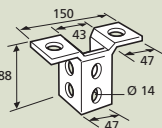

End cap C-41 profile

SC 951; 41 x 21 mm

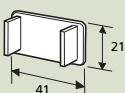

SC 950; 41 x 41mm

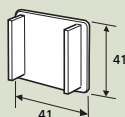

Cover

SC 952; 3000 x 41 mm

